

SHARP®

ELECTRONIC CASH REGISTER
ELEKTRONISCHE REGISTRIERKASSE
CAISSE ENREGISTREUSE ELECTRONIQUE
CAJA REGISTRADORA ELECTRONICA
ELEKTRONISCHE KASSA

MODEL
MODELL
MODELE
MODELO
MODEL

XE-A203

INSTRUCTION MANUAL
BEDIENUNGSANLEITUNG
MANUEL D'INSTRUCTIONS

MANUAL DE INSTRUCCIONES
GEBRUIKSAANWIJZING



With Quick Start Guide
Mit Schnellstartanleitung
Avec Guide de démarrage rapide
Con Guía de inicio rápido
Met Gids voor snel starten

CAUTION:

The cash register should be securely fitted to the supporting platforms to avoid instability when the drawer is open.

CAUTION:

The socket-outlet shall be installed near the equipment and shall be easily accessible.

VORSICHT:

Die Netzsteckdose muß nahe dem Gerät angebracht und leicht zugänglich sein.

ATTENTION:

La prise de courant murale devra être installée à proximité de l'équipement et devra être facilement accessible.

AVISO:

El tomacorriente debe estar instalado cerca del equipo y debe quedar bien accesible.

WARNING:

Det matande vägguttaget skall placeras nära apparaten och vara lätt åtkomligt.

LET OP:

Het stopcontact dient in de buurt van de kassa en gemakkelijk toegankelijk te zijn.

CAUTION:

For a complete electrical disconnection pull out the mains plug.

VORSICHT:

Zur vollständigen elektrischen Trennung vom Netz den Netzstecker ziehen.

ATTENTION:

Pour obtenir une mise hors-circuit totale, débrancher la prise de courant secteur.

AVISO:

Para una desconexión eléctrica completa, desenchufar el enchufe de tomacorriente.

WARNING:

För att helt koppla från strömmen, dra ut stickproppen.

LET OP:

Trek de stekker uit het stopcontact indien u de stroom geheel wilt uitschakelen.

Warning

This is a Class A product. In a domestic environment this product may cause radio interference in which case the user may be required to take adequate measures.

Warnung

Dies ist eine Einrichtung der Klasse A. Diese Einrichtung kann im Wohnbereich Funkstörungen verursachen; in diesem Fall kann vom Betreiber verlangt werden, angemessene Maßnahmen durchzuführen und dafür aufzukommen.

Avertissement

Ceci est un produit de Classe A. Dans un environnement domestique ce produit risque de provoquer une interférence radio, auquel cas l'utilisateur sera obligé d'observer les mesures adéquates.

Advertencia

Este es un producto de la clase A. En un ambiente doméstico es posible que este producto cause radiointerferencia. En este caso se solicita al usuario que tome medidas adecuadas.

Contact the following for the CE mark.

SHARP ELECTRONICS (Europe) GmbH
Sonninstraße 3, D-20097 Hamburg

INTRODUCTION

Thank you very much for your purchase of the SHARP Electronic Cash Register, Model XE-A203. Please read this manual carefully before operating your machine in order to gain full understanding of functions and features.

Please keep this manual for future reference. It will help you if you encounter any operational problems.

CAUTION!

Never install the batteries into the cash register before initializing it. Before you start operating the cash register, you must first initialize it, then install three new alkaline batteries LR6 ("AA" size) on the register. Otherwise, distorted memory contents and malfunction of the cash register will occur. For this procedure, please refer to pages 8 to 9.

IMPORTANT

- **Be very careful when removing and replacing the printer cover, as the cutter mounted on it is very sharp.**
- **Install the cash register in a location not subject to direct sunlight, unusual temperature changes, high humidity or splashing water.**
Installation in such locations could cause damage to the cabinet and the electronic components.
- **Never operate the register with wet hands.**
The water could seep into the interior of the register and cause component failure.
- **When cleaning your register, use a dry, soft cloth. Never use solvents, such as benzene and/or thinner.**
The use of such chemicals will lead to discoloration or deterioration of the cabinet.
- **The register plugs into any standard wall outlet (official (nominal) voltage).**
Other electrical devices on the same electrical circuit could cause the register to malfunction.
- **For protection against data loss, please install three alkaline batteries LR6 ("AA" size) after initializing the cash register. When handling the batteries, please observe the following:**
Incorrectly using batteries can cause them to burst or leak, possibly damaging the interior of the cash register.
 - **RISK OF EXPLOSION IF BATTERY IS REPLACED BY AN INCORRECT TYPE. DISPOSE OF USED BATTERIES ACCORDING TO THE INSTRUCTIONS.**
 - **Be sure that the positive (+) and negative (-) poles of each battery are facing in the proper direction for installation.**
 - **Never mix batteries of different types.**
 - **Never mix old batteries and new ones.**
 - **Never leave dead batteries in the battery compartment.**
 - **Remove the batteries if you do not plan to use the cash register for long periods.**
 - **Should a battery leak, clean out the battery compartment immediately, taking care to avoid letting the battery fluid come into direct contact with your skin.**
 - **For battery disposal, follow the corresponding law in your country.**
- **For complete electrical disconnection, disconnect the main plug.**

CONTENTS

INTRODUCTION	1
IMPORTANT	1
CONTENTS	2

Part1 QUICK START GUIDE

STEP1 PARTS AND THEIR FUNCTIONS.....	5
1 External View	5
2 Printer	5
3 Mode Switch and Mode Keys	6
4 Keyboard	6
5 Displays	7
6 Drawer Lock Key	7
STEP2 PREPARING THE CASH REGISTER	8
1 Initializing the Cash Register	8
2 Installing Batteries	9
3 Installing a Paper Roll	10
STEP3 BASIC FUNCTION PROGRAMMING.....	12
1 Abbreviations and Terminology	12
2 Prior to Programming	12
Procedure for programming	12
Description of special keys	12
Guidance for text programming	13
3 Language Selection	14
4 Date and Time Programming	14
5 Tax Programming	15
6 Department Programming	16
7 PLU (Price Look-Up) and Subdepartment Programming	21
8 Text Programming	23
Clerk names	23
Logo messages	23
9 Programming Other Necessary Items	24
STEP4 BASIC SALES ENTRY	25
1 Basic Sales Entry Example	25
2 PLU Entry	26
STEP5 CORRECTION	27
1 Cancellation of the Numeric Entry	27
2 Correction of the Last Entry (direct void)	27
3 Correction of the Next-to-last or Earlier Entry (indirect void)	28
4 Subtotal Void	28
5 Correction of Incorrect Entries not Handled by the Direct or Indirect Void Function	29
STEP6 FULL SALES REPORT (Z REPORT).....	30

Part2 FOR THE OPERATOR

OTHER BASIC SALES ENTRIES32

- 1 Additional Information for BASIC SALES ENTRY32
- 2 Error Warning32
- 3 Item Entries33
 - Single item entries33
 - Repeat entries34
 - Multiplication entries35
 - Single item cash sale (SICS) entry35
- 4 Displaying Subtotals36
- 5 Finalization of Transaction36
 - Cash or cheque tendering36
 - Cash or cheque sale that does not require tender entry36
 - Credit sale37
 - Mixed-tender sale37
- 6 Computation of VAT (Value Added Tax)/tax37
 - VAT/tax system37

OPTIONAL FEATURES.....39

- 1 Auxiliary Entries.....39
 - Percent calculations (premium or discount)39
 - Deduction entries.....39
 - Refund entries40
 - Non-add code number entries and printing40
- 2 Auxiliary Payment Treatment41
 - Currency exchange41
 - Received-on account entries42
 - Paid-out entries42
 - No sale (exchange)42
- 3 Automatic Sequence Key (AUTO key) Entries.....42

Part3 FOR THE MANAGER

PRIOR TO PROGRAMMING	43
AUXILIARY FUNCTION PROGRAMMING	46
1 Miscellaneous Key Programming.....	46
Programming for <input type="checkbox"/>	46
Programming for <input type="checkbox"/> %1 and <input type="checkbox"/> %2	48
Programming for <input type="checkbox"/> EX.....	51
Programming for <input type="checkbox"/> RA, <input type="checkbox"/> RCPTIPO, <input type="checkbox"/> CH1, <input type="checkbox"/> CH2, <input type="checkbox"/> CR1 and <input type="checkbox"/> CR2.....	52
Function parameters for <input type="checkbox"/> TL/NS.....	54
2 Other Text Programming.....	55
Foreign currency symbol	55
Domestic currency symbol	55
Training mode text.....	56
Function text.....	56
ADVANCED FUNCTION PROGRAMMING	58
1 Register Number and Consecutive Number Programming.....	58
2 Various Function Selection Programming 1	59
Function selection for miscellaneous keys	59
Print format	60
Receipt print format	60
Other programming	61
3 Various Function Selection Programming 2	66
Power save mode.....	66
Logo message print format.....	66
Thermal printer density.....	67
EJ memory type.....	67
Training clerk specification for training mode	67
AUTO key programming - Automatic sequence key	68
4 EURO Programming	69
5 Reading Stored Programs.....	70
TRAINING MODE	73
READING (X) AND RESETTING (Z) OF SALES TOTALS	74
EJ REPORT READING AND RESETTING	76
OVERRIDE ENTRIES	77
CORRECTION AFTER FINALIZING A TRANSACTION (Void mode)	77
EURO MIGRATION FUNCTION	78
OPERATOR MAINTENANCE	81
1 In Case of Power Failure.....	81
2 In Case of Printer Error	81
3 Cautions in Handling the Printer and Recording Paper.....	81
4 Replacing the Batteries	82
5 Replacing the Paper Roll.....	82
6 Removing a Paper Jam.....	85
7 Cleaning the Printer (Print Head / Sensor / Roller)	85
8 Removing the Till and the Drawer	86
9 Opening the Drawer by Hand.....	86
10 Before Calling for Service.....	87
Error message table	87
SPECIFICATIONS	88

Part1 QUICK START GUIDE

STEP 1 PARTS AND THEIR FUNCTIONS

1 External View

■ Front view

Operator display

Printer cover

Receipt paper

Drawer lock

Drawer

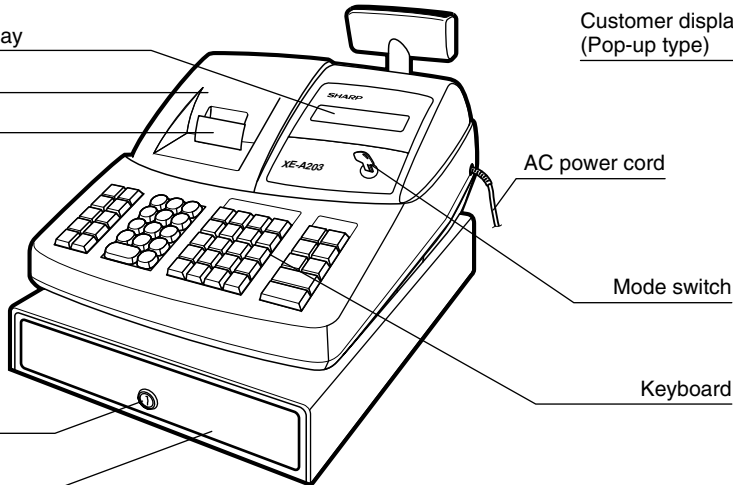

■ Rear view

Customer display
(Pop-up type)

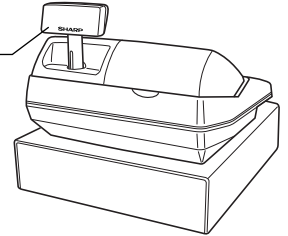

2 Printer

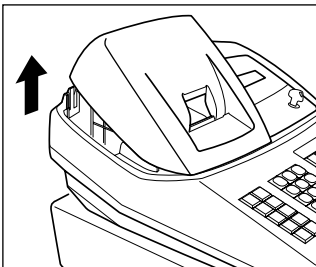

The printer is one station type thermal printer, therefore it does not require any type of ink ribbon or cartridge.

Lift the rear of the printer cover to remove. To re-install, hook the pawls on the cabinet and close.

Caution: The paper cutter is mounted on the printer cover. Be careful not to cut yourself.

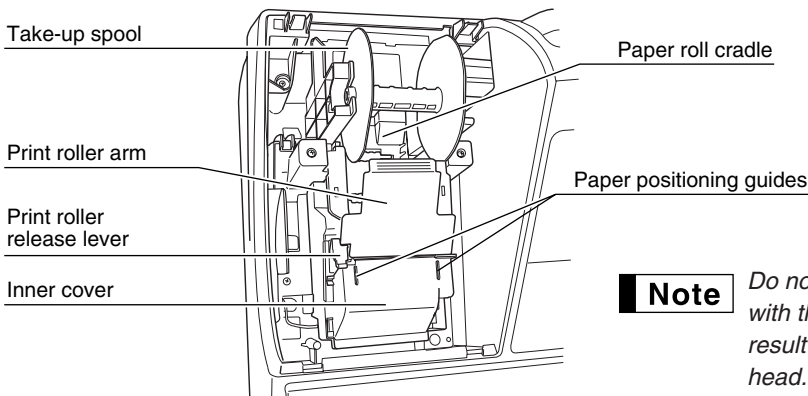

Note

Do not attempt to remove the paper roll with the print roller arm locked. This may result in damage to the printer and print head.

3 Mode Switch and Mode Keys

The mode switch can be operated by inserting one of the two supplied mode keys - manager (MA) and operator (OP) keys. These keys can be inserted or removed only in the "REG" or "⏻" position.

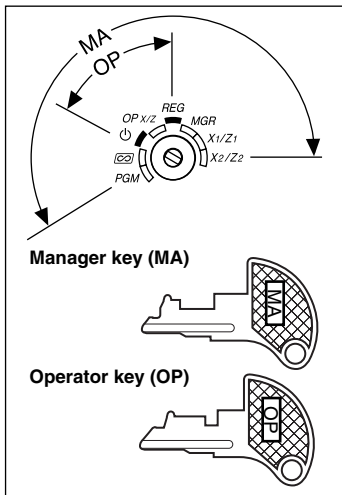

The mode switch has these settings:

- ⏻ :** This mode locks all register operations. (AC power turns off.)
No change occurs to register data.
- OP X/Z:** To take individual clerk X or Z reports, and to take flash reports. It can be used to toggle receipt state "ON" and "OFF" by pressing the **RCPT/PO** key.
- REG:** For entering sales.
- PGM:** To program various items.
- ∞ :** Enters into the void mode. This mode allows correction after finalizing a transaction.
- MGR:** For manager's entries. The manager can use this mode for an override entry.
- X1/Z1:** To take the X/Z report for various daily totals.
- X2/Z2:** To take the X/Z report for periodic (weekly or monthly) consolidation.

4 Keyboard

Keyboard layout

↑	EX	⊗	•	CL	PLU /SUB A	DEPT # F	DEPT SHIFT K	CLK# P	VAT U	AUTO X
RA !	%1 /	7	8	9	20 4 B	24 8 G	28 12 L	32 16 Q	CR2 V	CH2 Y
RCPT /PO _	%2 NUMBER	4	5	6	19 3 C	23 7 H	27 11 M	31 15 R	CR1 W	CH1 Z
∞ DC	RF SHIFT	1	2	3	18 2 D	22 6 I	26 10 N	30 14 S	#/TM/ST	
ESC BS	⊖ SPACE	0		00	17 1 E	21 5 J	25 9 O	29 13 T	TL/NS	

Key names

↑	Paper feed key	⊖	Discount key	CLK#	Clerk code entry key	
RA	Received-on account key	⊗	Multiplication key	1 ¹⁷ ~ 16 ³²	Department keys	
RCPT /PO	Receipt print/Paid-out key	•	Decimal point key	VAT	Value added tax key	
∞	Void key	CL	Clear key	AUTO	Automatic sequence key	
ESC	Escape key	00	0 ~ 9	CR1	CR2	Credit 1 and 2 keys
EX	Foreign currency exchange key	PLU /SUB	PLU/Subdepartment key	CH1	CH2	Cheque 1 and 2 keys
%1 %2	Percent 1 and 2 keys	DEPT #	Department code entry key	#/TM/ST	Non-add code/Time display /Subtotal key	
RF	Refund key	DEPT SHIFT	Department shift key	TL/NS	Total/No sale key	

5 Displays

Operator display

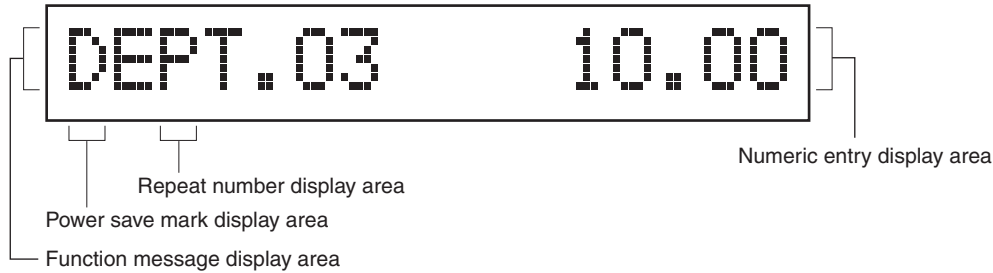

- **Repeat number display area**

The number of repeats is displayed, starting at “2” and incremental with each repeat. When you have registered ten times, the display will show “0”. (2 → 39 → 0 → 1 → 2...)

- **Power save mark display area**

When the cash register goes into the power save mode, the power save mark (decimal point) lights up.

- **Function message display area**



Item labels of departments and PLU/subdepartments and function texts you use, such as %, (-) and CASH are displayed. For the details of function texts, please refer to page 57.

When an amount is to be entered or entered, “AMOUNT” is displayed: When an amount is to be entered, ----- is displayed at the numeric entry area with “AMOUNT”. When a preset price has been set, the price is displayed at the numeric entry area with “AMOUNT”.

- **Numeric entry display area**

Numbers entered using numeric keys are displayed here.

Date and time display

Date and time appear on the display in the , OP X/Z, REG, or MGR mode. In the , REG or MGR mode, press the  key to display the date and time.

Error message

When an error occurs, the corresponding error message is displayed in the function message display area. For details of error messages, please refer to “Error message table” on page 87.

Customer display (Pop-up type)

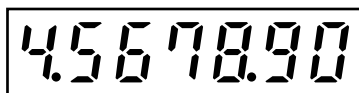

6 Drawer Lock Key

This key locks and unlocks the drawer. To lock it, turn 90 degrees counterclockwise. To unlock it, turn 90 degrees clockwise.

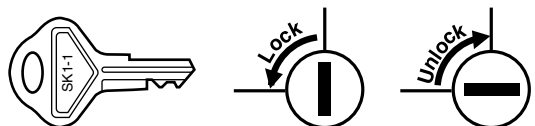

STEP 2 PREPARING THE CASH REGISTER

Unpack the cash register and make sure all accessories are included. For details of accessories, please refer to "SPECIFICATIONS" section on page 88.

For installing the cash register, find a stable surface near an AC outlet where the cash register will not be subject to water sources or direct sunlight.

For preparing the cash register, please follow the three steps shown below; "1 Initializing the Cash Register" on page 8, "2 Installing Batteries" on page 9, and "3 Installing a Paper Roll" on page 10.

1 Initializing the Cash Register

In order to operate the cash register properly, you must initialize it before operating for the first time. Follow this procedure.

1. Insert the manager (MA) key into the mode switch and turn it to the REG position.
2. Insert the plug of the AC power cord into the AC outlet. The buzzer will sound three times.

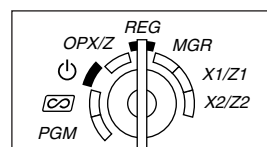

IMPORTANT: This operation must be performed without batteries installed.

3. The cash register has now been initialized. The register display will show "0.00" and then "NO BATTERY".

NO BATTERY

Note

If the buzzer does not sound when the plug is inserted, the initialization has not been done successfully. (This will occur when the voltage is high because you operated the cash register before starting initialization.) Wait at least one minute after pulling out the plug and insert the plug again.

2 Installing Batteries

Three new alkaline batteries LR6 ("AA"size) must be installed in the cash register to prevent the data and user-programmed settings from being erased from the memory, when the AC cord is accidentally disconnected or in case of power failure. Once installed, the batteries will last approximately one year before needing replacement. At this time, the warning message "LOW BATTERY" will appear on the display to indicate the batteries are low and must be replaced within two days. If the warning message "NO BATTERY" appears, you must install the batteries at once. Do not set the mode switch to the \cup , ∞ nor PGM positions while "NO BATTERY" is being displayed.

Install three new alkaline batteries LR6 ("AA"size) according to the procedure shown below with the AC cord connected and set the mode switch to the REG position:

1. Push the printer cover forward and detach it.
Be careful with the paper cutter, so as not to cut yourself.
2. Open the battery compartment cover next to the paper roll cradle.

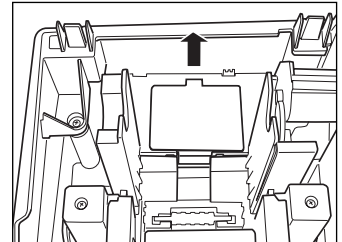

3. Install three new alkaline batteries LR6 ("AA"size) as per the diagram.
When the batteries are properly installed "NO BATTERY" message on the display will disappear.
4. Close the battery compartment cover.

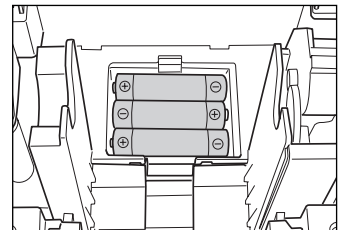

Note

- Be sure to observe precautions shown on page 1 when handling batteries.
- If you press a key by mistake, an error message "PAPER EMPTY" may be displayed. Press the CL key to clear message after installing paper rolls.

Caution

"LOW BATTERY" or "NO BATTERY" can be displayed only when the cash register is being turned on. Please be advised that when the cash register is being turned off for a long time, the data in memory might be cleared without the warning messages: "LOW BATTERY" or "NO BATTERY".

3 Installing a Paper Roll

Precaution: The paper cutter is mounted on the printer cover. Take caution when removing and installing the cover.

The register can print receipts or journals. For the printer, you must install the paper roll provided with the register, even when you program the register for not printing receipts or journals.

Install the paper roll according to the procedure shown below with the AC cord connected and the mode switch set to the REG position:

1. Lift up the print roller release lever to unlock and open the print roller arm.

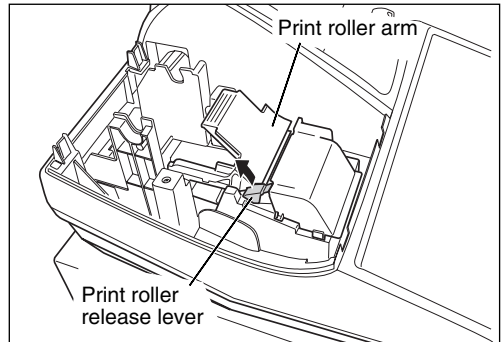

2. Set a paper roll in the paper roll cradle as per the diagram.

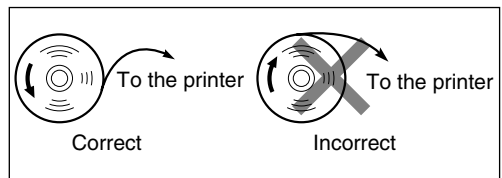

3. Feed the end of the paper along with the paper positioning guides as per the diagram.

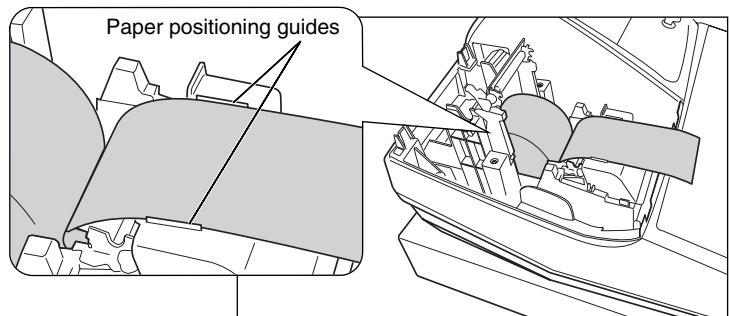

4. While holding down the paper, slowly close the print roller arm, and push down the arm until you hear a click locking the arm. Make sure securely you push down the center of the wing part of the arm as per the diagram. The paper will be fed automatically.

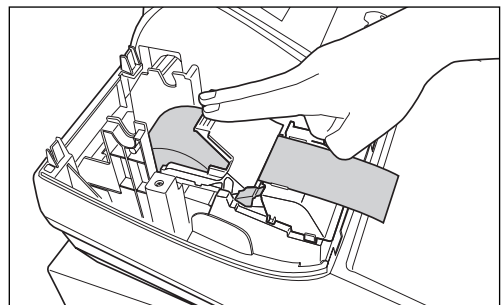

Note

If the print roller arm is not securely locked, printing is not done right. If this problem occurs, open the arm, and close the arm as instructed above.



5. When not using the take-up spool (using as receipt paper):

- Cut off the excess paper using the edge of the inner cover, and replace the printer cover. Press the  key to make sure the paper end comes out of the printer cover and clean paper appears.

Note

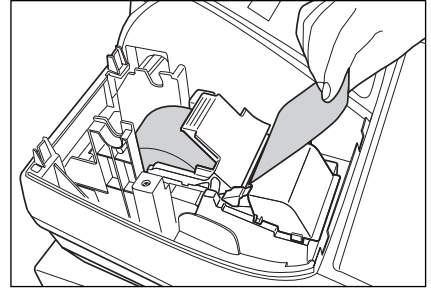
If the paper end does not come out, open the printer cover, and pass the paper end between the paper cutter and the paper guide of the printer cover, and replace the cover.

**When using the take-up spool (using as journal paper):**

- Insert the end of the paper into the slit in the spool. (Press the  key to feed more paper if required.)
- Wind the paper two or three turns around the spool shaft.
- Set the spool on the bearing, and press the  key to take up excess slack in the paper.
- Replace the printer cover.

Note

When using a paper roll as journal paper, you must change the printing style. Refer to "Print format" in "Various Function Selection Programming 1" section (Job code 6) for changing the printing style.

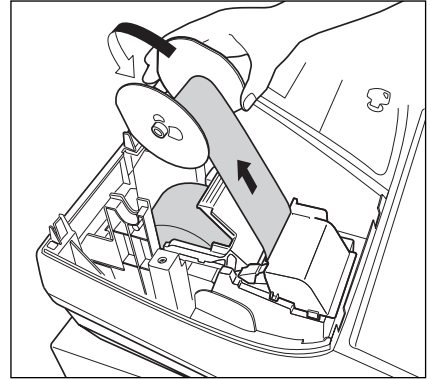

STEP 3 BASIC FUNCTION PROGRAMMING

Before starting sales entries, you must first program necessary items so the cash register suits your sales needs. In this manual, there are three sections, **BASIC FUNCTION PROGRAMMING (pages 12-24) where required items must be programmed**, **AUXILIARY FUNCTION PROGRAMMING (pages 46-57) where you can program for more convenient use of keys on the keyboard**, and **ADVANCED FUNCTION PROGRAMMING (pages 58-72) where various optional programming features are provided**. Find the appropriate features for your needs, and make the necessary programming.

1 Abbreviations and Terminology

- Dept.: Department; a category for merchandise classifications. Every sales item should belong to a department.
- PLU: Price Look Up; a category for merchandise classifications. PLUs are used to call up preset prices by a code entry.
- VAT: Value Added Tax
- X report: Report to read sales data
- Z report: Report to read and reset sales data

2 Prior to Programming

■ Procedure for programming

1. Check to see whether a paper roll is present in the machine. If there is not enough paper on a roll, replace it with a new one (refer to "Replacing the Paper Roll" on page 82 for the replacement).
2. Put the manager key in the mode switch and turn it to the PGM position.
3. Program necessary items into the cash register.
Every time you program an item, the cash register will print the setting. Please refer to print samples in each section.
4. If necessary, issue programming reports for your reference.

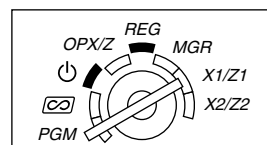

- Note**
- On the key operation example shown in the programming details, numbers such as "22052007" indicates the parameter which must be entered using the corresponding numeric keys.
 - Asterisks in the tables shown in the programming details indicate default settings.

■ Description of special keys

	to	Numerical key	Used for numerical number entry.
		Double-zero key	Used for parameter entry and character code entry.
		Clear key	Used for cancel entry.
		Point key	Used for decimal point entry and right moving entry (as right cursor key).
		Multiplication key	Used for left moving entry (as left cursor key).
		Subtotal key	Used for data decision entry.
		Finalization key	Used for programming termination entry.

■ Guidance for text programming

The register allow you to program texts for department item names (page 16), PLU/subdepartment item names (page 21), function texts (page 56), clerk names (page 23), logo messages (page 23), foreign and domestic currency symbols (page 55), and training mode texts (page 56).

There are two ways for programming text; using character keys on the keyboard or entering character codes with numeric keys on the keyboard. For the latter way, refer to "Entering character codes with numeric keys on the keyboard" on page 44.

Using character keys on the keyboard

You can enter characters according to the small figures printed in the lower right position of the tops. For the layout, please refer to "Keyboard" section on page 6.

The following are used as control keys for character entry:

- SHIFT** Toggles between upper-case and lower-case letters. By default, the upper-case letter is selected. Once the **SHIFT** key is pressed, you are locked in for entering lower-case letters. "a" is displayed when lower-case letters entry is selected as shown in the operator display example below.
- NUMBER** Press the **NUMBER** key to enter numeric characters. For example to enter "1", press the **NUMBER** and **1** key. If you press the **1** key without pressing the **NUMBER** key, the cash register goes to character codes entry mode. Once the **NUMBER** key is pressed, you are locked in for entering numeric characters. "1" is displayed when numeric characters entry is selected.
- DC** Toggles between single-size and double-size characters. By default, the single-size character is selected. Once the **DC** key is pressed, you are locked in for entering double size characters. "W" is displayed when double-size characters entry is selected as shown in the operator display example below.
- BS** Backs up the cursor, erasing the character to the left.

Operator display (Example)

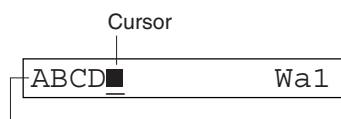

Characters entered using character keys are displayed here.

Example To program the word "Clerk01" with the letter "C" being double size.

To make the letter "C" double size character	DC C	=C W
To make character size return to normal size	DC	=C
To toggle the characters to lower-case letters	SHIFT	=C a
	L E R K	=Clerk a
To enter numbers	NUMBER 0 1	=Clerk01 a1

5 Tax Programming

If you program the VAT/tax, the cash register can calculate the sales tax. In the VAT system, the tax is included in the price you enter in the register, and the tax amount is calculated when tendered according to the VAT rate programmed. In the tax system, the tax is calculated when tendered according to the tax rate programmed, and added to the price. The cash register can provide totally 6 kinds of VAT/tax systems (automatic VAT1-4, automatic tax 1-4, manual VAT 1-4, manual VAT 1, manual tax 1-4, and automatic VAT1 and automatic tax 2-4 systems) and 4 kinds of rates. By default, the cash register is pre-programmed as automatic VAT1-4 system.

When you program tax rate(s) and taxable status for each department (by default, VAT1/tax1 is set to taxable.), tax will be automatically added to sales of items assigned to the department according to the programmed tax status for the department and the corresponding tax rate(s).

For details of the tax systems, refer to "Computation of VAT (Value Added Tax)/tax" section on page 37. To change the tax system, please refer to "Other programming" of "Various Function Selection Programming 1" section (Job code 69) on page 65.

■ Tax rate programming

The percent rate specified here is used for tax calculation on taxable subtotals.

Procedure

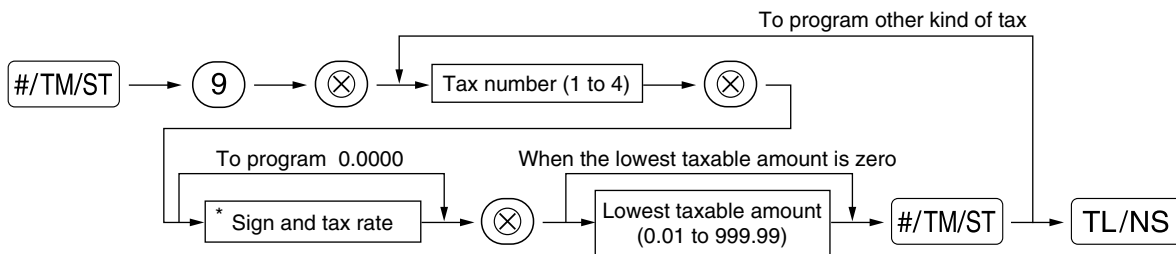

*Sign and tax rate: XYYY.YYYY
 Tax rate=0.0000 to 100.0000
 Sign -/+ = 1/0

For entering tax number, sign and tax rate and lowest taxable amount, the register displays guidance messages, "ENTER TAX NO.", "ENTER TAX RATE", and "ENTER LOWER TAX" respectively.

Key operation example	Operator display	Print
#/TM/ST 9 ⊗	TAX RATE PROG.	<div style="border: 1px solid black; padding: 5px;"> <p>*PGM*</p> <p>T2 7.0000%</p> <p> 0.00</p> </div>
	ENTER TAX NO.	
2 ⊗	ENTER TAX RATE	
7 ⊗	ENTER LOWER TAX	
#/TM/ST	ENTER TAX NO.	
TL/NS	0.00	

Note

- The lowest taxable amount is valid only when you select add on tax system. If you select VAT (Value added system), it is ignored.
- If you make an incorrect entry before pressing the third ⊗ key in programming a tax rate, cancel it with the Ⓞ key.
- You do not need to enter the trailing zeros of the tax rate (after the decimal point), but you do need to enter the decimal for fractions.
- If you select VAT system, the sign which you program is ignored.

To delete a tax rate, use the following sequence:

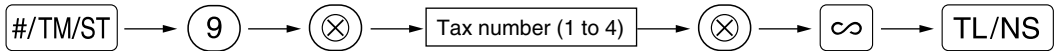
Procedure**6 Department Programming**

Merchandise can be classified into a maximum of 99 departments. Items sold using the department keys can later be printed on a report shown as the quantities sold and sales amounts classified by department. The data is useful for making purchasing decisions and other store operations.

Default setting for the VAT/tax statuses and signs are listed below.

Dept. code:	VAT/tax status:	Sign:
Dept. 1-10	VAT 1	(+)
Dept. 11-20	VAT 2	(+)
Dept. 21	VAT 1	(-)
Dept. 22-99	VAT 1	(+)

Procedure**Note**

- To keep current setting on each programming, press the #/TM/ST key when the corresponding guidance message is firstly displayed.
- When pressing the TL/NS key in the middle of procedure, the programming will terminate and the data you entered before the press of TL/NS is saved.
- When pressing the Ⓞ key twice in the middle of procedure, the programming will terminate and the data you entered before pressing the Ⓞ key twice is NOT saved.
- When pressing the PLU, ⊖, %1, %2, EX, RA, RCPTPO, CH1, CH2, CR1 or CR2 key in the middle of procedure except while entering texts or prices, the programming will move to the pressed key programming.

Key operation**Operator display****1. Specify the department code.**

- (1) For dept.1 through 16, press the department key.
 For dept.17 through 32, press the DEPTSHIFT key, and then press the department key.
 Or enter dept. code using numeric key, and then press the DEPT# key.
 Immediately after displaying the current text data and the corresponding dept. key code you entered, guidance message for the next step will be displayed.

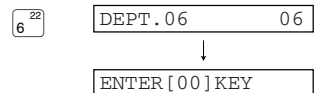

2. Text programming (Press to skip. / Press to terminate.)

- (1) Press key to enter text programming.
Immediately after displaying guidance message, the current text data will be displayed.

↓

- (2) Enter an item name.
A maximum of 16 characters can be entered.
Please refer to "Guidance for text programming" on page 13 for entering the item name.
When you start entering a character, the current text data will be overwritten by new data.
Pressing the and key moves the cursor to the right and left respectively.

BOOK

- (3) Press the key to register the item name.
Immediately after displaying guidance message for the next step, the current setting for the next step will be displayed.

↓

3. Unit price programming (Press to skip. / Press to terminate.)

- (1) Enter a unit price using numeric keys.
A maximum of 6 digits can be set.
Default setting is 0.

300

- (2) Press the key to register the unit price.
Immediately after displaying guidance message for the next step, the current setting for the next step will be displayed.

↓

4. Entry type programming (Press to skip. / Press to terminate.)

- (1) Press key 3 times to display "PRESET".
Each time key is pressed, the display shows "INHIBITED", "OPEN", "PRESET" and "OPEN & PRESET" in this order.
Default setting is "OPEN".
When the unit price is changed from the default setting ("0") in step 3, "OPEN & PRESET" will be displayed first.
However, when the default setting is not changed, "OPEN" will be displayed first.

- (2) Press the key to register the entry type.
Immediately after displaying guidance message for the next step, the current setting for the next step will be displayed.

↓

5. VAT/tax 1 status programming (Press to skip. / Press to terminate.)

- (1) Go to (2) when the VAT/tax 1 status does not need to be changed from "TAX1 YES". Otherwise, press key to display "TAX1 NO".
Each time key is pressed, the display shows "TAX1 NO" and "TAX1 YES" alternatively.
Choose "YES" for taxable and "NO" for non-taxable.
Default setting is "YES" for dept. code 1 to 10 and 21 to 99, and "NO" for dept. code 11 to 20.
When any entry of a taxable department is made in a transaction, tax is automatically computed according to the associated tax rate as soon as the transaction is completed.

- (2) Press the key to register the setting.
Immediately after displaying guidance message for the next step, the current setting for the next step will be displayed.

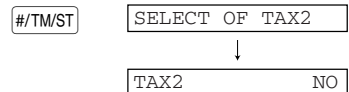

6. VAT/tax2 status programming (Press to skip. / Press to terminate.)

- (1) Go to (2) when the VAT/tax 2 status does not need to be changed from "TAX2 NO". Otherwise, press key to display "TAX2 YES".
Each time key is pressed, the display shows "TAX2 YES" and "TAX2 NO" alternatively.
Default setting is "NO" for dept. code 1 to 10 and 21 to 99, and "YES" for dept. code 11 to 20.

- (2) Press the key to register the setting.
Immediately after displaying guidance message for the next step, the current setting for the next step will be displayed.

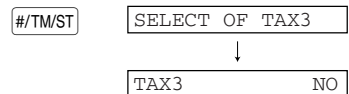

7. VAT/tax3 status programming (Press to skip. / Press to terminate.)

- (1) Go to (2) when the VAT/tax 3 status does not need to be changed from "TAX3 NO". Otherwise, press key to display "TAX3 YES".
Each time key is pressed, the display shows "TAX3 YES" and "TAX3 NO" alternatively.
Default setting is "NO".

- (2) Press the key to register the setting.
Immediately after displaying guidance message for the next step, the current setting for the next step will be displayed.

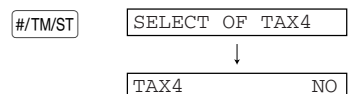

8. VAT/tax4 status programming (Press to skip. / Press to terminate.)

- (1) Go to (2) when the VAT/tax 4 status does not need to be changed from "TAX4 NO". Otherwise, press key to display "TAX4 YES".
Each time key is pressed, the display shows "TAX4 YES" and "TAX4 NO" alternatively.
Default setting is "NO".

- (2) Press the key to register the setting.
Immediately after displaying guidance message for the next step, the current setting for the next step will be displayed.



9. Registration type programming (Press to skip. / Press to terminate.)

- (1) Go to (2) when the registration type does not need to be changed from "NORMAL". Otherwise, press key to display "SICS".
Each time key is pressed, the display shows "SICS" and "NORMAL" alternatively.
Choose "SICS" for single item cash sale and "NORMAL" for normal sale.
Default setting is "NORMAL".
If an entry of a department programmed for SICS is made first, the sale will be finalized as a cash sale as soon as the department key is pressed. If the entry is made after entering a department not programmed for SICS, the sale will not be finalized until the key is pressed.

- (2) Press the key to register the setting.
Immediately after displaying guidance message for the next step, the current setting for the next step will be displayed.



10. Sign programming (Press to skip. / Press to terminate.)

- (1) Go to (2) when the sign does not need to be changed from "(+)". Otherwise, press key to display "(-)".
Each time key is pressed, the display shows "(-)" and "(+)" alternatively.
Choose "(+)" for positive department and "(-)" for negative department.
Default setting is "(+)" for dept. code 1 to 20 and 22 to 99, and "(-)" for dept. code 21.

- (2) Press the key to register the setting.
Immediately after displaying guidance message for the next step, the current setting for the next step will be displayed.

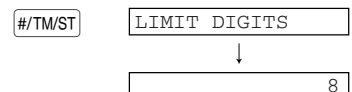

11. Entry digit limit programming (Press to skip. / Press to terminate.)

- (1) Enter entry digit limit using numeric key.
The entry digit limit can be set up to 8.
Default setting is 8.

7

- (2) Press the key to register the setting.
Immediately after displaying current text setting and the corresponding department code for the next department, guidance message will be displayed.
The dept. code is automatically incremented for a new department key programming, and ready for text programming for the incremented dept. code.

↓

To program for the incremented dept. code, return to the step 2.

When you want to program for other than incremented dept. code, return to the step 1.

12. Terminate programming

- (1) Press the key to terminate department code programming.

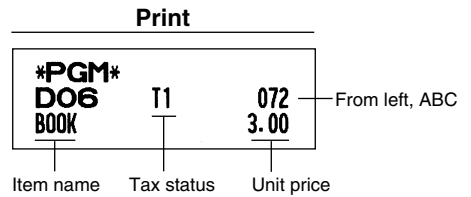

Item:	Selection:	Print:
A SICS/Normal	Normal*	0
	SICS	1
B Entry digit limit		0-8(default:8)
C Type of unit price entry	Open and preset	3
	Preset only	2
	Open only*	1
	Inhibit department key	0

7 PLU (Price Look-Up) and Subdepartment Programming

The PLU function allows speedy key entries whereby a price is automatically called up when a code is entered. The subdepartment is a kind of “open PLU”, which requires you to enter a price after the PLU code is entered. By default, PLU/subdepartment setting for 1 through 210 codes are possible, and can extend to 1200. To extend the number, please refer to “EJ memory type” on page 67.

Procedure

Note

- To keep current setting on each programming, press the **#/TM/ST** key when the corresponding guidance message is firstly displayed.
- When pressing the **TL/NS** key in the middle of procedure, the programming will terminate and the data you entered before the press of **TL/NS** is saved.
- When pressing the **CL** key twice in the middle of procedure, the programming will terminate and the data you entered before pressing the **CL** key twice is NOT saved.
- When pressing the department, **⊖**, **%1**, **%2**, **EX**, **RA**, **RCPT/PO**, **CH1**, **CH2**, **CR1** or **CR2** key in the middle of procedure except while entering texts or prices, the programming will move to the pressed key programming.

Key operation

Operator display

1. Specify the PLU code.

- (1) Enter PLU code using numeric key, and then press the **PLU/SUB** key.
Immediately after displaying the current text data and the corresponding PLU code you entered, guidance message for the next step will be displayed.

71 **PLU/SUB** PLU.0071 0071
↓
ENTER [00] KEY

2. Text programming (Press **#/TM/ST** to skip. / Press **TL/NS** to terminate.)

- (1) Press **00** key to enter text programming.
Immediately after displaying guidance message, the current text data will be displayed.
- (2) Enter an item name.
A maximum of 16 characters can be entered.
Please refer to “Guidance for text programming” on page 13 for entering the item name.
When you start entering a character, the current text data will be overwritten by new data.
Pressing the **⊙** and **⊗** key moves the cursor to the right and left respectively.
- (3) Press the **#/TM/ST** key to register the item name.
Immediately after displaying guidance message for the next step, the current setting for the next step will be displayed.

00 ENTER TEXT
↓
PLU.0071

MELON MELON_

#/TM/ST PRICE
↓
0.00

3. Unit price programming (Press **#/TM/ST** to skip. / Press **TL/NS** to terminate.)

- (1) Enter a unit price using numeric keys.
A maximum of 6 digits can be set.
For a subdepartment, set the limit amount of unit price entry.
Default setting is 0.

500 500

- (2) Press the key to register the unit price.
Guidance message for the next step will be displayed.

4. Associated dept. programming (Press to skip. / Press to terminate.)

- (1) Enter an associated dept. code using numeric key.
For dept. 1 through 16, you may press the corresponding department key.
For dept.17 through 32, you may press the key, and then press the corresponding department key.
Default setting is dept. 1.
For deleting PLU, enter 0 instead of an associated dept. code.

1

- (2) Press the key to register the associated dept. code.
Immediately after displaying guidance message for the next step, the current setting for the next step will be displayed.

↓

5. Function programming (Press to skip. / Press to terminate.)

- (1) Go to (2) when the function does not need to be changed from "PLU". Otherwise, press key to display "SUBDEPT".
Each time key is pressed, the display shows "SUBDEPT" and "PLU" alternatively.
Choose "PLU" for using the PLU code as PLU and "SUBDEPT" for using the PLU code as subdepartment.
Default setting is "PLU".

- (2) Press the key to register the setting.
Immediately after displaying current text setting and the corresponding PLU code for the next PLU, guidance message will be displayed.
The PLU code is automatically incremented for a new PLU programming, and ready for text programming for the incremented PLU code.

↓

To program for the incremented PLU code, return to the step 2.
When you want to program for other than incremented PLU code, return to the step 1.

6. Terminate programming

- (1) Press the key to terminate PLU programming.

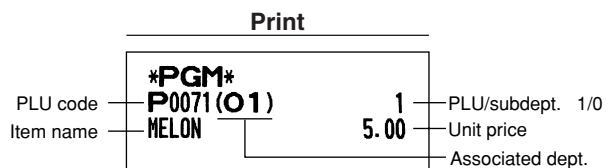

8 Text Programming

Please refer to "Guidance for text programming" on page 13 as for how to entering characters.

When you press an appropriate number key (job code number) and press the \odot key for text entry just after you start programming with the $\#/\text{TM}/\text{ST}$ key, the cash register will automatically be ready for text entry.

Then a little after displaying guidance message indicating what programming you are in, the register may ask you to enter the first parameter. Referring to the corresponding "Procedure", enter a parameter and start character entries.

■ Clerk names (12 digits)

Procedure

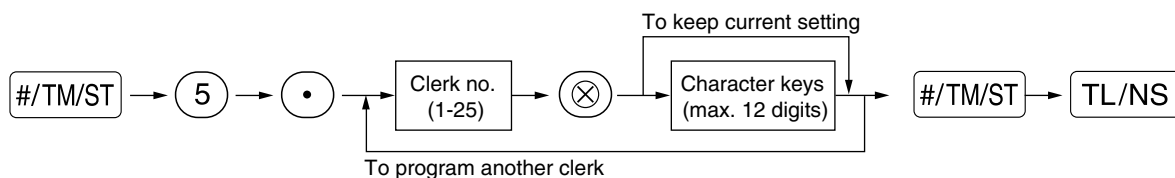

Key operation example

$\#/\text{TM}/\text{ST}$ 5 \odot

1 \otimes

DAVID

$\#/\text{TM}/\text{ST}$

TL/NS

Operator display

CLERK NAME PROG.
ENTER CLERK NO.

DAVID_
CLERK NAME PROG.
ENTER CLERK NO.

0.00

Print

PGM
C#01 DAVID

■ Logo messages (6 lines and 24 digits for each line)

The register can print programmed messages on every receipt. On the standard model, a 6-line logo message is printed on the receipt. If you want to print in other logo message format, please change the format. For the programming details, refer to page 66. The options are listed below:

Procedure

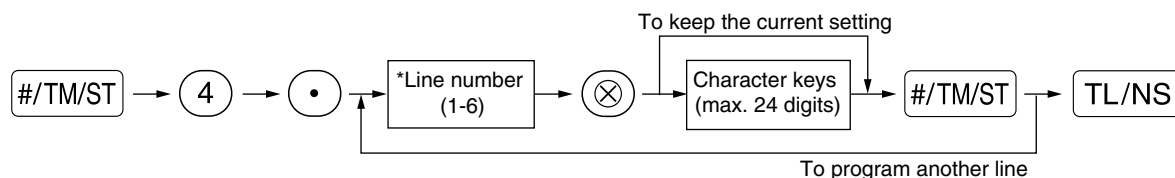

* "Header 3-line message" type: 1 to 3

"Header 6-line message" type: 1 to 6

"Header 3-line and footer 3-line message" type: 1 to 6 (1 to 3 as header, 4 to 6 as footer)

Logo message print format (3 types)

Header 1st line
Header 2nd line
Header 3rd line

Header 3-line message

Header 1st line
Header 2nd line
Header 3rd line
Header 4th line
Header 5th line
Header 6th line

Header 6-line message

Header 1st line
Header 2nd line
Header 3rd line
Footer 4th line
Footer 5th line
Footer 6th line

Header 3-line message and footer 3-line messages (Default setting)

To print the logo message "THANK YOU" using double sized characters and centering on the third line.

Key operation example	Operator display	Print
#/TM/ST 4 ●	LOGO TEXT PROG.	*PGM* THANK YOU
3 ⊗	ENTER LINE NO.	
SPACE SPACE SPACE	__	
DC	__ W	
THANK SPACE YOU	N=K= =Y=O=U_ W	
DC	N=K= =Y=O=U_	
SPACE SPACE SPACE	= =Y=O=U _	
#/TM/ST	LOGO TEXT PROG.	
	ENTER LINE NO.	
TL/NS	0.00	

Note A 6-line logo message is preprogrammed when shipped. Please start entering from the first line when you first program a logo message.

9 Programming Other Necessary Items

Decimal point position (tab) setting for domestic currency

By default, "2" is selected. When your country has a different tab setting, you must change the setting. Please refer to "Other programming" of "Various Function Selection Programming 1" (Job code 61) on page 61.

Rounding system

When your country has a special rounding system, such as Australia, Switzerland, Norway, Sweden, Denmark and South Africa, you must change the setting to suit your country. For the setting for Australia, Switzerland, Norway and South Africa, please refer to "Other programming" of "Various Function Selection Programming 1" (Job code 67) on page 63. For the setting for Sweden and Denmark, please refer to "Other programming" of "Various Function Selection Programming 1" (Job code 69) on page 65.

STEP 4 BASIC SALES ENTRY

1 Basic Sales Entry Example

Listed below is a basic sales entry example when selling items by cash. For operation details, please refer to "Additional Information for BASIC SALES ENTRY" on page 32.

Mode switch setting

1. Turn the mode switch to the REG position.

Clerk assignment

2. Enter your clerk code. (For example, clerk code is 1. Press the 1 and \square CLK# key in this order.) The clerk code 1 is automatically selected just after initialization of the cash register.

Item entries

3. Enter the price for the first department item. (For example, for 15.00, enter 1 5 00, and press the appropriate department key.)

For department 17 to department 32, press the \square DEPTSHIFT key first before pressing the department key.

For department 33 and above, enter the department code using numeric keys and press the \square DEPT# key, then enter the price and press the \square DEPT# key again.

4. Repeat step 3 for all department items.

Displaying subtotals

5. Press the \square #/TM/ST key to display the amount due.

Finalizing the transaction

6. Enter the amount received from the customer. (You can omit this step if the amount tendered is the same as the subtotal.)
7. Press the \square TL/NS key, and the change due is displayed and the drawer is opened.
8. Tear off the receipt and give it to the customer with his or her change.
9. Close the drawer.

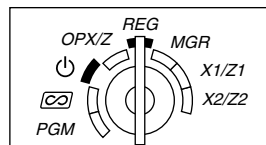

Key operation example Operator display

Clerk assignment	→ 1 \square CLK#	DAVID -01-
Item entries	{ 1500 \square 1 ¹⁷	DEPT.01 15.00
	{ 2300 \square 2 ¹⁸	DEPT.02 23.00
Displaying subtotal	→ \square #/TM/ST	SUBTOTAL 38.00
Amount tendered	→ 4000	4000
Finalizing the transaction	→ \square TL/NS	CHANGE 2.00

(In this example, tax system is set to automatic VAT 1 and the tax rate is set to 16.00%.)

Receipt print

SHARP PRESENTS THE BEST ECR		Logo message (Header)
22/05/2007 000000#000009		Date/Register number/ Consecutive number
14:33 01 DAVID		Time/Clerk code/Clerk name
DEPT. 01	*15.00	Items
DEPT. 02	*23.00	Price
SUBTOTAL	*38.00	
TAX1 ST	*38.00	Not printed when non-taxable items only are sold.
VAT 1	*5.24	
NET 1	*32.76	
ITEMS	20	Total quantity
***TOTAL	*38.00	Total amount
CASH	*40.00	Cash tendering/amount received
CHANGE	*2.00	Change
SHARP IS THE BEST		Logo message (Footer)

2 PLU Entry

Enter a PLU code using numeric keys and press the **PLU/SUB** key.

Key operation example	Operator display	Receipt print
Item entries { 1 71 141 TL/NS	PLU.0001 1.50	PLU.0001 *1.50
	PLU.0071 15.00	PLU.0071 *15.00
	PLU.0141 36.20	PLU.0141 *36.20
	CASH 52.70	ITEMS 3Q CASH *52.70

STEP 5 CORRECTION

1 Cancellation of the Numeric Entry

If you make an incorrect numeric entry, you can clear the entry by pressing the CL key only before pressing a department key, PLU/subdepartment key, the DEPT\# key, the \%1 key, the \%2 key, the \ominus key or the RF key.

2 Correction of the Last Entry (direct void)

If you make an incorrect entry relating to a department, PLU/subdepartment, percentage (\%1 and \%2), discount (\ominus) or refund, you can void this entry by pressing the ∞ key immediately after the incorrect entry.

Key operation example	Operator display	Receipt print
1250 6^{22}	DEPT.06 12.50	DEPT.06 *12.50
∞	DEPT.06 -12.50	DEPT.06 $\text{\textcircled{0}}-12.50$
2 PLU/SUB	PLU.0002 1.50	PLU.0002 *1.50
∞	PLU.0002 -1.50	PLU.0002 $\text{\textcircled{0}}-1.50$
600 8^{24}	DEPT.08 6.00	DEPT.08 *6.00
\%1	\%1 -0.90	-15.00%
∞	\%1 0.90	\%1 -0.90
1 PLU/SUB	PLU.0001 3.28	PLU.0001 $\text{\textcircled{0}}*3.28$
28 \ominus	(-) -0.28	(-) -0.28
∞	(-) 0.28	(-) $\text{\textcircled{0}}*0.28$
250 RF 6^{22}	DEPT.06 -2.50	DEPT.06 R-2.50
∞	DEPT.06 2.50	DEPT.06 $\text{R}\text{\textcircled{0}}*2.50$
TL/NS	CASH 9.28	ITEMS 20
		CASH *9.28

3 Correction of the Next-to-last or Earlier Entry (indirect void)

You can void any incorrect department entry, PLU/subdepartment entry or item refund entry made during a transaction if you find it before finalizing the transaction (e.g. pressing the **TL/NS** key). This function is applicable to department, PLU/subdepartment and refund entries only.

Press the **∞** key just before you press a department key, **DEPT#** key or **PLU/SUB** key. For the refund indirect void, press the **∞** key after you press the **RF** key.

Key operation example	Operator display	Receipt print
1310 6 ²²	DEPT.06 13.10	DEPT.06 *13.10 DEPT.07 *17.55 PLU.0010 *7.15 PLU.0012 *3.60 DEPT.06 R-2.50 DEPT.07 *8.25 DEPT.06 ∞ -13.10 PLU.0012 ∞ -3.60 DEPT.06 R ∞ *2.50 ITEMS 3Q CASH *32.95
1755 7 ²³	DEPT.07 17.55	
10 PLU/SUB	PLU.0010 7.15	
12 PLU/SUB	PLU.0012 3.60	
Correction of a department entry → 250 RF 6 ²²	DEPT.06 -2.50	
825 7 ²³	DEPT.07 8.25	
Correction of a PLU entry → 1310 ∞ 6 ²²	DEPT.06 -13.10	
12 ∞ PLU/SUB	PLU.0012 -3.60	
Correction of a refund entry → 250 RF ∞ 6 ²²	DEPT.06 2.50	
TL/NS	CASH 32.95	

4 Subtotal Void

You can void an entire transaction. Once subtotal void is executed, the transaction is aborted and the register issues a receipt. This function does not work when more than 30 items have been entered.

Key operation example	Operator display	Receipt print	
1310 2 ¹⁸	DEPT.02 13.10	DEPT.02 *13.10 DEPT.02 *13.10 DEPT.06 *17.55 PLU.0010 *7.15 PLU.0035 *10.00 SUBTOTAL *60.90 SBTL ∞ -60.90 ***TOTAL *0.00	
2 ¹⁸	2 13.10		
1755 6 ²²	DEPT.06 17.55		
10 PLU/SUB	PLU.0010 7.15		
35 PLU/SUB	PLU.0035 10.00		
Subtotal void {	#/TM/ST		SUBTOTAL 60.90
	∞		0.00
	#/TM/ST		***TOTAL 0.00

5 Correction of Incorrect Entries not Handled by the Direct or Indirect Void Function //

Any errors found after the entry of a transaction has been completed or during an amount tendered entry cannot be voided. These errors must be corrected by the manager.

The following steps should be taken:

- 1.** If making the amount tendered entry, finalize the transaction.
- 2.** Make correct entries from the beginning.
- 3.** Hand the incorrect receipt to the manager for its cancellation.

STEP 6

FULL SALES REPORT (Z REPORT)

For reading and resetting the sales data, use the resetting function (Z). Resetting prints all sales information and clears the entire memory except for the GT1 through GT3, Training GT, BAL, reset count, and consecutive number.

For more information about resetting (Z) of sales totals, refer to "READING (X) AND RESETTING (Z) OF SALES TOTALS" on page 74.

Full sales report

Put the manager key in the mode switch and turn it to the X1/Z1 position.

Key operation

TL/NS

Operator display

0.00

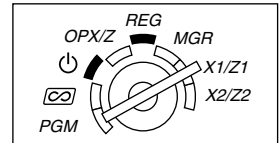

Sample report

² *Z1*	Mode title*1
Z1 0001	Reset counter
GT1 *00000001227.45	Net grand total (GT2-GT3)
GT2 *00000001362.63	Grand total of plus registration
GT3 -00000000135.18	Grand total of minus registration
TR *00000000000.00	Grand total of training mode registration

* DEPT *	
D01 35 Q	Dept. code
DEPT. 01 *606.35	Sales q ty
D02 23 Q	Sales amount
DEPT. 02 *431.50	
D03 3 Q	
DEPT. 03 *36.10	
D04 2 Q	
DEPT. 04 *61.45	

D99 2 Q	
DEPT. 99 *40.00	
*DEPT TL 71 Q	+ dept. counter and total
*1277.60	

D35 2 Q	
DEPT. 35 -17.50	
DEPT (-) 2 Q	- dept. counter and total
-17.50	

*TRANS. *	
(-) 1 Q	Subtotal counter and total
-4.00	
%1 2 Q	
-10.15	Subtotal percent counter and total
%2 1 Q	
-18.50	
NET 1 *1227.45	Net sales total

TAX1 ST *1227.45	Taxable 1 total
VAT 1 *169.30	VAT 1 total
TAX2 ST *1007.41	
VAT 2 *65.91	
TTL TAX *235.21	Tax total
NET *992.24	Net total without tax

(-) 2 Q	Item counter and total
-7.00	
%1 1 Q	
-3.90	Item percent counter and total
%2 1 Q	
-3.13	
REFUND 1 Q	Refund counter and total
*15.00	
∞ 1 Q	REG-mode void counter and total
*15.00	
∞ MODE 1 Q	Void-mode transaction counter and total
*41.00	
MGR ∞ 2 Q	Manager item void counter and total
*41.00	
SBTL ∞ 2 Q	Subtotal void counter and total
*68.50	

NO SALE 2 Q	No-sales counter
***RA 1 Q	Received on account counter and total
*48.00	
***PO 1 Q	Paid out counter and total
*23.00	

GUEST 23 Q	Customer counter
PAID TL *1227.42	Paid total
AVE. *53.37	Paid total average per customer

(To be continued on the next page)

CASH	12 Q	*804.32	Cash counter and total
CHECK1	2 Q	*69.70	Cheque1 sales counter and total
CHECK2	1 Q	*48.00	
CREDIT1	1 Q	*12.60	Credit1 sale and tendering counter and total
CREDIT2	2 Q	*33.80	
EXCH1	2 Q	US \$18.34	Exchange counter and total (in preset rate entry)
DOM. CUR1		*19.51	Domestic currency
EXCH2	1 Q	110.00	Exchange manual rate entry counter and total
DOM. CUR2		*86.27	
EX1 CHK	1 Q	US \$112.33	Exchange check (in preset rate entry)
DOM. CUR1		*119.50	
EX1 CR	1 Q	US \$33.84	Exchange credit (in preset rate entry)
DOM. CUR1		*36.00	

***CID		*827.04	Cash in drawer
*CH ID		*117.70	Cheque in drawer
CA/CH ID		*944.74	Cash + cheque in drawer
CHK/CG		*2.00	Change total for cheque tendering

- *1: When you take X1 report, "X1" is printed.
- *2: Printed in the Z1 report only.
- *3: When "Memory of difference due to rounding" is set to "yes" the following is displayed here. For changing the setting, refer to "Other programming" (job code 67).

DIFFER	-0.03
---------------	--------------

- *4: When manual tax 1-4 system or auto tax 1-4 system is selected, the following is displayed here. For changing the setting, refer to "Other programming" (job code 69).

NET2	*1227.45	Sales total including tax
-------------	-----------------	---------------------------

■ Periodic consolidation

Put the manager key in the mode switch and turn it to the X2/Z2 position.

Key operation	Operator display
 TL/NS	0.00

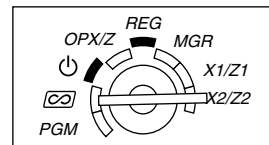

Sample report

Z2		Mode title*1
	Z1 0001	Reset counter of daily total
	Z2 0001	Reset counter of periodic consolidation
GT1	*00000001227.45	Grand total
GT2	*00000001362.63	
GT3	-00000000135.18	
TR	*00000000000.00	

The subsequent printouts are the same in format as in the X1/Z1 full sales report.

- *1: When you take X2 report, "X2" is printed.
- *2: Printed in the Z2 report only



Part2 FOR THE OPERATOR

OTHER BASIC SALES ENTRIES

1 Additional Information for BASIC SALES ENTRY

Clerk assignment

Prior to any item entries, clerks must enter their clerk codes into the register. However, the code entry may not be necessary when the same clerk handles the consecutive transactions.

■ Sign-on (in REG, MGR, mode)

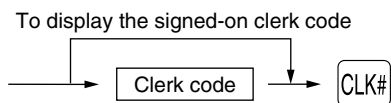

■ Sign-off (in REG, MGR, mode)

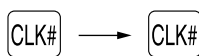

Receipt ON/OFF function

When you use the printer to issue receipts, you can disable receipt printing in the REG mode to save paper using the receipt ON/OFF function. To disable receipt printing, press the  key in the OP X/Z position. This key toggles the receipt printing status ON and OFF.

The register will print reports regardless of the receipt state, so the paper roll must be installed.

To issue a receipt when receipt ON/OFF function is set to OFF:

If your customer wants a receipt after you finalized a transaction with the receipt ON/OFF function being OFF status, press the  key. This will produce a receipt. However, if more than 30 items were entered, the receipt will be issued in a summary receipt.

Copy receipt

You can print a copy receipt by pressing the  key when the receipt ON/OFF function is in the "ON" status. To realize this function, you must enable the function. Please refer to page 62 (Job code 63).







Power Save Mode

The register will enter into power save mode when no entries are performed based on the pre-programmed time limit (by default, 30 minutes).

When the register goes to the power save mode, all display lights will turn off except the decimal point at the leftmost position. The register will return to the normal operation mode when any key is pressed or a mode is changed with the mode key. Please note when the register is recovered by a key entry, its key entry is invalid. After the recovery, start the key entry from the beginning.

2 Error Warning

In the following examples, your register will go into an error state accompanied with a warning beep and a corresponding error message. Clear the error state by pressing the  key and take the proper action. Please refer to the error message table on page 87.

- Enter over a 32-digit number (entry limit overflow): Cancel the entry and re-enter the correct number.
- An error in key operation: Clear the error and continue operation.
- An entry beyond a programmed amount entry limit: Check to see if the entered amount is correct. If it is correct, it can be rung up in the MGR mode. Contact your manager.
- An including-tax subtotal exceeds eight digits: Delete the subtotal by pressing the  key and press the , , ,  or  key to finalize the transaction.

Error escape function

To quit a transaction due to an error or an unforeseen event, use the error escape function as shown below:

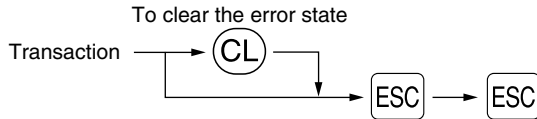

The transaction is voided (treated as a subtotal void) and the receipt is issued by this function. If you have already entered a tendered amount, the operation is finalized as a cash sale.

3 Item Entries

Single item entries

1. Department entries

The cash register provides a maximum of 99 departments for a merchandise classification. Group attributes, such as taxable status, are applied to items when they are entered to the departments.

• When using the department keys (for department 1 to 32)

For department 1 to 16, enter a unit price and press a department key. If you use a programmed unit price, press a department key only.

For department 17 to 32, enter a unit price, press the **DEPTSHIFT** key and press a department key. If you use a programmed unit price, press the **DEPTSHIFT** key and press a department key.

When using a programmed unit price

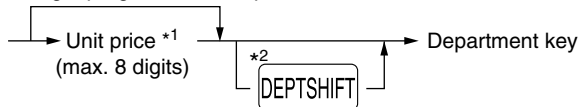

*1 Less than the programmed upper limit amounts
When zero is entered, only the sales quantity is added.

*2 For the departments 17 through 32, press the **DEPTSHIFT** key.

Note

Please note if you press the same key after using the **DEPTSHIFT** key, it acts as a repeat entry. For example, when you register an item of dept. 17 using the **DEPTSHIFT** key and then an item of dept. 1 using the preset unit price, you should use the department code entry key described below for the dept. 1 item. If you just press the **1** key to register dept. 1 item, it will act as a repeat entry of dept. 17 item.

• When using the department code entry key

Enter a department (dept.) code and press the **DEPT#** key, then enter a unit price and press the **DEPT#** key again. If you use a programmed unit price, enter a dept. code and press the **DEPT#** key.

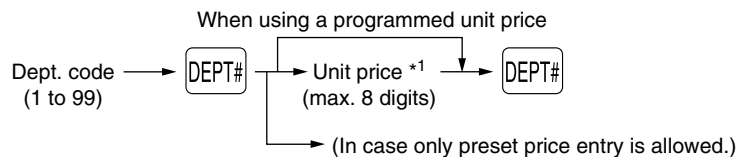

*1 Less than the programmed upper limit amounts
When zero is entered, only the sales quantity is added.

2. PLU/subdepartment entries

For another merchandise classification, the cash register provides a maximum of 1200 PLUs/subdepartments. PLUs are used to call up preset prices by a code entry. Subdepartments are used to classify merchandise into smaller groups under the departments. Every PLU and subdepartment has a code from 1 to 1200, and should belong to a department to obtain attributes of that department.

By default, the cash register is preprogrammed to be able to use 1 to 210 codes, and these 210 codes are set to PLU mode and zero for unit price.

To extend the number of PLU codes to 1200, please refer to "EJ memory type" on page 67, and for other PLU/subdepartment programming, refer to "PLU (Price Look-Up) and Subdepartment Programming" on page 21.

• **PLU entries**

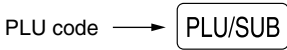

• **Subdepartment (open PLU) entries**

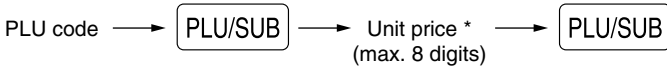

* Less than the programmed upper limit amounts
When zero is entered, only the sales quantity is added.

Key operation example

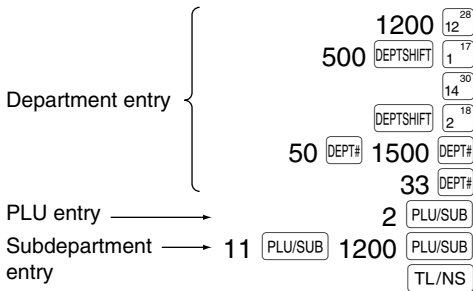

Receipt print

DEPT. 12	*12.00
DEPT. 17	*5.00
DEPT. 14	*8.25
DEPT. 18	*3.25
DEPT. 50	*15.00
DEPT. 33	*2.50
PLU.0002	*1.50
PLU.0011	*12.00
ITEMS	8Q
CASH	*59.50

■ **Repeat entries**

You can use this function for entering a sale of two or more of the same items. Consecutive pressing of a department key, DEPT# key or PLU/SUB key is as shown on key operation example below.

Key operation example

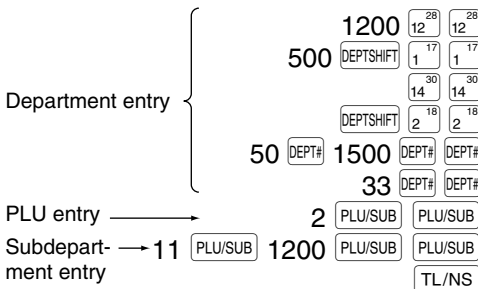

Receipt print

DEPT. 12	*12.00
DEPT. 12	*12.00
DEPT. 17	*5.00
DEPT. 17	*5.00
DEPT. 14	*8.25
DEPT. 14	*8.25
DEPT. 18	*3.25
DEPT. 18	*3.25
DEPT. 50	*15.00
DEPT. 50	*15.00
DEPT. 33	*2.50
DEPT. 33	*2.50
PLU.0002	*1.50
PLU.0002	*1.50
PLU.0011	*12.00
PLU.0011	*12.00
ITEMS	16Q
CASH	*119.00

■ Multiplication entries

When selling a large quantity of items, it is convenient to use the multiplication entry method. Enter quantity using numeric keys and press the \otimes key before starting item entry as shown in the example below.

Note

When programmed to allow fractional quantity entries, you can enter up to four integers and three digit decimal, though the quantity is counted as one for sales reports. To enter a fractional quantity, use the decimal point key between integer and decimal, as $(7) \cdot (5)$ for entering 7.5.

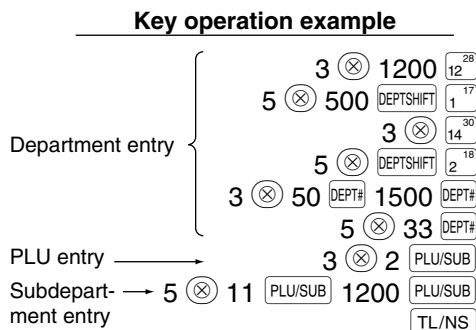

Receipt print

3x 12.00	
DEPT. 12	*36.00
5x 5.00	
DEPT. 17	*25.00
3x 8.25	
DEPT. 14	*24.75
5x 3.25	
DEPT. 18	*16.25
3x 15.00	
DEPT. 50	*45.00
5x 2.50	
DEPT. 33	*12.50
3x 1.50	
PLU. 0002	*4.50
5x 12.00	
PLU. 0011	*60.00
ITEMS	32Q
CASH	*224.00

■ Single item cash sale (SICS) entry

- This function is useful when a sale is for only one item and is for cash. This function is applicable only to those departments that have been set for SICS or to their associated PLUs or subdepartments.
- The transaction is complete and the drawer opens as soon as you press the department key, (DEPT\#) key or (PLU/SUB) key.

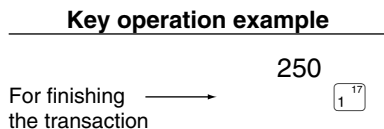

Receipt print

DEPT. 01	*2.50
ITEMS	1Q
CASH	*2.50

Note

If an entry to a department or PLU/subdepartment set for SICS follows the ones to departments or PLUs/subdepartments not set for SICS, it does not finalize and results in a normal sale.

4 Displaying Subtotals

The subtotal is displayed by pressing the **[#/TM/ST]** key. When you press it, the subtotal of all entries which have been made is displayed with the function message "SUBTOTAL".

Note Subtotal will not be printed on a receipt on the current factory setting. If you want to print it, change the setting by programming. Refer to "Receipt print format" (Job code 7) on page 60.

5 Finalization of Transaction

■ Cash or cheque tendering

Press the **[#/TM/ST]** key to get a subtotal, enter the amount tendered by your customer, then press the **[TL/NS]** key if it is a cash tender or press a cheque key (**[CH1]** or **[CH2]**) if it is a cheque tender. When the amount tendered is greater than the amount of the sale, the register will show the change due amount with the function message "CHANGE". Otherwise the register will show a deficit with the function message "DUE". You now must make a correct tender entry.

Cash tendering

Key operation example

}
[#/TM/ST]
 1000 **[TL/NS]**

Receipt print

ITEMS	3Q	
***TOTAL		*7.35
CASH		*10.00
CHANGE		*2.65

Cheque tendering

Key operation example

}
[#/TM/ST]
 1000 **[CH1]**

Receipt print

ITEMS	3Q	
***TOTAL		*7.35
CHECK1		*10.00
CHANGE		*2.65

■ Cash or cheque sale that does not require tender entry

Enter items and press the **[TL/NS]** key if it is a cash sale or press a cheque key if it is a cheque sale. The register will display the total sale amount.

Key operation example

300 **[6]**²²
 10 **[PLU/SUB]**
[TL/NS]

Receipt print

DEPT.06		*3.00
PLU.0010		*7.15
ITEMS	2Q	
CASH		*10.15

In the case of cheque 1 sale

ITEMS	2Q	
CHECK1		*10.15

Note When programmed not to allow "direct non-tender finalization after tendering" (Job code 63, refer to page 62), you must always enter a tender amount.

■ Credit sale

Enter items and press a credit key (**CR1** or **CR2**).

Key operation example

2500 **6**²²
 3250 **7**²³
CR1

Receipt print

DEPT. 06	*25. 00
DEPT. 07	*32. 50
ITEMS	2Q
CREDIT1	*57. 50

■ Mixed-tender sale

You can perform mixed-tendering of cheque and cash, cash and credit, and cheque and credit.

Key operation example

}
#/TM/ST
 950 **TL/NS**
CR2

Receipt print

ITEMS	3Q
***TOTAL	*49. 50
CASH	*9. 50
CREDIT2	*40. 00

6 Computation of VAT (Value Added Tax)/tax

■ VAT/ tax system

The cash register may be programmed for the following six VAT/tax systems. The cash register is pre-programmed as automatic VAT 1-4 system.

Automatic VAT 1-4 system (Automatic operation method using programmed percentages)

This system, at settlement, calculates VAT for taxable 1 through 4 subtotals by using the corresponding programmed percentages.

Automatic tax 1-4 system (Automatic operation method using programmed percentages)

This system, at settlement, calculates taxes for taxable 1 through 4 subtotals by using the corresponding programmed percentages, and also adds the the calculated taxes to those subtotals, respectively.

Manual VAT 1-4 system (Manual entry method using programmed percentages)

→ **#/TM/ST** → **VAT**

This system provides the VAT calculation for taxable 1 through 4 subtotals. This calculation is performed using the corresponding programmed percentages when the **VAT** key is pressed just after the **#/TM/ST** key.

Manual VAT 1 system (Manual entry method for subtotals that uses VAT 1 preset percentages)

To use a programmed rate

→ **#/TM/ST** → VAT rate → **VAT**

This system enables the VAT calculation for the then subtotal. This calculation is performed using the VAT 1 preset percentages when the **VAT** key is pressed just after the **#/TM/ST** key. For this system, the keyed-in tax rate can be used.

Manual tax 1-4 system (Manual entry method using preset percentages)



This system provides the tax calculation for taxable 1 through 4 subtotals. This calculation is performed using the corresponding programmed percentages when the **VAT** key is pressed just after the **#/TM/ST** key. After this calculation, you must finalize the transaction.

Automatic VAT 1 and automatic tax 2-4 system

This system enables the calculation in the combination with automatic VAT 1 and automatic tax 2 through 4. The combination can be any of VAT1 corresponding to taxable 1 and any of tax 2 through 4 corresponding to taxable 2 through taxable 4 for each item. The tax amount is calculated automatically with the percentages previously programmed for these taxes.

Note

- The tax status of PLU/subdepartment depends on the tax status of the department which the PLU/subdepartment belongs to.
- VAT/tax assignment symbol can be printed at the fixed right position near the amount on the receipt as follows:

VAT1/tax1 —————> A
 VAT2/tax2 —————> B
 VAT3/tax3 —————> C
 VAT4/tax4 —————> D

When the multiple VAT/tax is assigned to a department or a PLU, a symbol of the lowest number assigned to VAT/tax rate will be printed. For programming, please refer to "Various Function Selection Programming 1" (Job code 66) on page 63.

Key operation example

(When the manual VAT 1-4 system is selected)

1000 **1**¹⁷
#/TM/ST
VAT
TL/NS

Receipt print

DEPT. 01	*10.00
SUBTOTAL	*10.00
TAX1 ST	*10.00
VAT 1	*1.38
NET 1	*8.62
ITEMS	1Q
CASH	*10.00

OPTIONAL FEATURES

1 Auxiliary Entries

■ Percent calculations (premium or discount)

Your register provides the percent calculation for the subtotal and/or each item entry depending on the programming. Refer to "Programming for [%1] and [%2]" for the programming.

- Percentage: 0.01 to 100.00% (Depending on the programming)

Application of preset rate (if programmed) and manual rate entry are available.

Percent calculation for subtotal

Key operation example

4
 140 ²¹
 570 ²³

 10

Receipt print

4x 1.40	
DEPT. 05	*5.60
DEPT. 07	*5.70
SUBTOTAL	*11.30
%1	-10%
	-1.13
ITEMS	5Q
CASH	*10.17

Percent calculation for item entries

Key operation example

800 ²²
 7 5
 15

(When premium and 15% are programmed for the [%2] key)

Receipt print

DEPT. 06	*8.00
	-7.5%
%1	-0.60
PLU. 0015	*5.00
	15.00%
%2	*0.75
ITEMS	2Q
CASH	*13.15

■ Deduction entries

Your register allows you to deduct a preset amount or a certain amount manually entered, which are less than a programmed upper limit. These calculations can be after the entry of an item and/or the computation of subtotal depending on the programming. Refer to "Programming for [⊖]" for the programming.

Deduction for subtotal

Key operation example

575 ²²
 10

 100

Receipt print

DEPT. 06	*5.75
PLU. 0010	*7.15
SUBTOTAL	*12.90
(-)	-1.00
ITEMS	2Q
CASH	*11.90

Deduction for item entries

Key operation example

675 ²³

(When a deduction amount of 0.75 is programmed.)

Receipt print

DEPT. 07	*6.75
(-)	-0.75
ITEMS	1Q
CASH	*6.00

Refund entries

For departments 1 to 16, enter the refund amount and press the key, and then press the corresponding department key and for departments 17 to 32, enter the refund amount and press the key, then press the key and press the corresponding department key (when using the preset price, omit entering the amount). In case of department 33 to 99, enter the department code and press key and the key, then enter the refund amount and press the key if necessary.

For a refund of a PLU item, enter the PLU code and press the key, then press the key.

For a refund of a subdepartment item, enter the PLU code and press the key and key, then enter the refund amount and press the key.

Key operation example

250 ²²
 41 100
 7
 13
 85 150

Receipt print

DEPT. 06	R-2.50
DEPT. 41	R-1.00
-7x 2.10	
PLU. 0013	R-14.70
PLU. 0085	R-1.50
ITEMS	0Q
CHANGE	*19.70

Non-add code number entries and printing

You can enter a non-add code number such as a customer's code number and credit card number, a maximum of 16 digits, at any point during the entry of a sale. The cash register will print it at once.

To enter a non-add code number, enter the number and press the key.

Key operation example

1230
 1500 ²²

Receipt print

	#0000000000001230
DEPT. 06	*15.00
ITEMS	1Q
CREDIT1	*15.00

2 Auxiliary Payment Treatment

■ Currency exchange

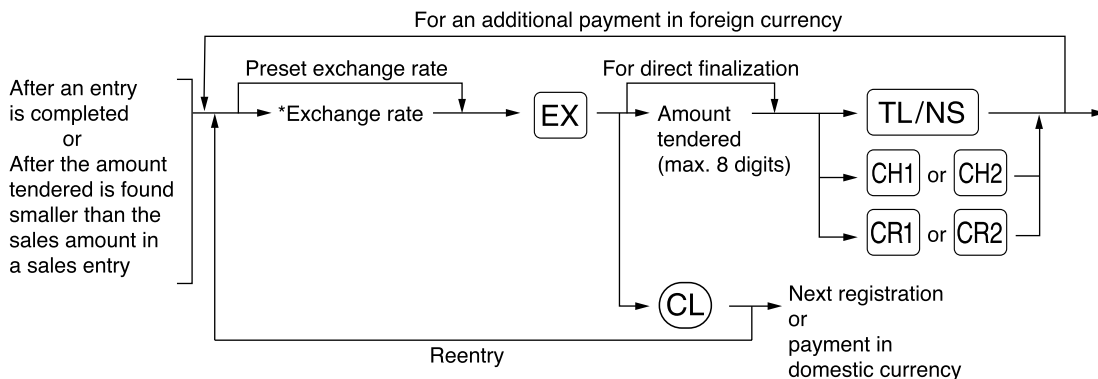

*Exchange rate: 0.000000 to 999.999999

Note

- Press the **CL** key after pressing the **EX** key to cancel payment in a foreign currency.
- If "Yes" is selected for cheque and credit operation when tendering in foreign currency in EURO programming, you can finalize a sale in foreign currency using the **CH1**, **CH2**, **CR1** or **CR2** key with preset exchange rate operation.
- If programmed, a foreign currency symbol is printed when you use a preset rate. Refer to "Foreign currency symbol" for the programming.
- Refer to "Programming for **EX**" for programming the currency exchange rate.

Applying preset exchange rate

Key operation example

2300 **6**²²
 4650 **7**²³
 Currency exchange → **EX**
 Amount tendered in foreign currency → 10000 **TL/NS**

(When a currency exchange rate of 0.939938 is programmed for the **EX** key.)

Receipt print

DEPT. 06	*23.00	
DEPT. 07	*46.50	
ITEMS	2Q	
***TOTAL	*69.50	Domestic currency
EXCH1	0.939938	Exchange rate
	US \$65.33	Foreign currency
CASH	US \$100.00	
CHANGE	*36.88	Domestic currency

Foreign currency symbol
(Printed if programmed)

Applying manual exchange rate

Key operation example

2300 **6**²²
 4650 **7**²³
 Exchange rate → 1 **•** 275 **EX**
 10000 **TL/NS**

Receipt print

DEPT. 06	*23.00
DEPT. 07	*46.50
ITEMS	2Q
***TOTAL	*69.50
EXCH2	1.275
	88.62
CASH	100.00
CHANGE	*8.92

■ Received-on account entries

When you receive on account from a customer, use the **RA** key. For the received-on-account (RA) entry, enter the amount, and press the **RA** key.

Note Cash tendering only available for RA operation.

Key operation example

12345 **#/TM/ST**
4800 **RA**

Receipt print

***RA #0000000000012345
*48.00

■ Paid-out entries

When you pay an amount to a vendor, use the **RCPTPO** key. For the paid-out (PO) entry, enter the amount and press the **RCPTPO** key.

Note Cash tendering only available for PO operation.

Key operation example

54321 **#/TM/ST**
2300 **RCPTPO**

Receipt print

***PO #0000000000054321
*23.00

■ No sale (exchange)

When you need to open the drawer with no sale, press the **TL/NS** key. The drawer will open and printer will print "NO SALE" on the receipt or journal. If you let the machine print a non-add code number before pressing the **TL/NS** key, a no sale entry is achieved and a non-add code number is printed. Refer to "Other programming" (job code 63) for the programming.

#0000000000045678
NO SALE

3 Automatic Sequence Key (**AUTO** key) Entries

You can achieve a programmed transaction simply by pressing the **AUTO** key. Refer to "AUTO key programming - Automatic sequence key" for the programming.

Key operation example

AUTO
(**AUTO**) = 500 **6** **22** **TL/NS**

Receipt print

DEPT.06 *5.00
ITEMS 1Q
CASH *5.00

Part3 FOR THE MANAGER

PRIOR TO PROGRAMMING

■ Procedure for programming

1. Check to see whether a paper roll is present in the machine. If there is not enough paper on a roll, replace it with a new one (refer to "Replacing the Paper Roll" on page 82 for the replacement).
2. Put the manager key in the mode switch and turn it to the PGM position.
3. Program necessary items into the cash register.

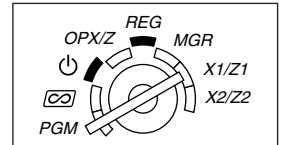

Every time you program an item, the cash register will print the setting. Please refer to print samples in each section.

4. If necessary, issue programming reports for your reference.

Note

- On the key operation example shown in the programming details, numbers such as "22052007" indicates the parameter which must be entered using the corresponding numeric keys.
- Asterisks in the tables shown in the programming details indicate default settings.

■ Guidance messages

Depending on programming items, the register shows guidance messages on the operator display to indicate a programming item you are in, or guidance to enter data, as shown in the examples below.

Your register allows you to program all necessary data in one procedure with the guidance messages for department programming (page 16), PLU (Price Look-Up) and subdepartment programming (page 21), programming for the \ominus , %1, %2, EX, RA, RCPTPO, CH1, CH2, CR1 and CR2 keys (pages 46-54). For their guidance messages, please refer to each section.

Example 1: For key entry type programming

Key operation example	Operator display
Parameter/price entry → 008 ⊗ (In case of parameter entry)	008
Press of the subjected key → #/TM/ST • Guidance message is displayed.	PAYMENT KEY PROG
To terminate → TL/NS	0.00

To repeat (depending on programming)
Guidance message is kept displaying until you press the TL/NS key.

Example 2: Job code type programming (programming starting from the press of #/TM/ST.)

Key operation example	Operator display
Job code entry • Guidance message is displayed.	MACHINE NO.
Parameter entry	50
Registration of parameter	ENTER [TL/NS] KEY
To terminate	0.00

To repeat (depending on programming)
Guidance message is changed after a new job code entry.

■ Entering character codes with numeric keys on the keyboard

For entering numerals, letters or symbols, enter a character code using numeric keys and press the numeric key 00. For the character codes, please refer to the alphanumeric character code table on the next page. By doing this, you can program characters other than those on the key tops. For entering numerals and letters using character keys, refer to "Using character keys on the keyboard" on page 13.

- Double-size characters can be made by entering the character code 253 or pressing the DC key. "W" is displayed when double-size characters entry is selected as shown in the operator display example below.
- All three digits of the character code MUST be entered (even if it starts with zero).

Key operation example	Operator display
253 00	<div style="border: 1px solid black; padding: 2px; display: flex; align-items: center;"> Cursor <div style="border: 1px solid black; padding: 2px; flex-grow: 1;"> W </div> </div> <p>Characters entered are displayed here.</p>
065	<div style="border: 1px solid black; padding: 2px; display: flex; align-items: center;"> <div style="border: 1px solid black; padding: 2px; flex-grow: 1;">065</div> </div> <p>Character code</p>
00	<div style="border: 1px solid black; padding: 2px; display: flex; align-items: center;"> =A <div style="border: 1px solid black; padding: 2px; flex-grow: 1;"> W </div> </div> <p>Characters: Indicating double size character of "A"</p>

Example

To program the word "SHARP" in double-size characters

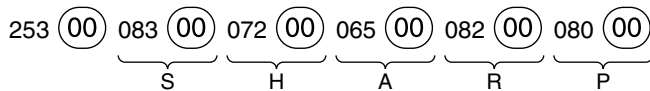

Alphanumeric character code table

Code	Character	Code	Character	Code	Character	Code	Character	Code	Character
001	á	046	.	091	Ä	136	→	193	ı
002	â	047	/	092	Ö	137	ſ	194	Ĝ
003	ê	048	0	093	Ü	138	ſ	195	Ş
004	î	049	1	094	^	139	◀	196	Ĝ
005	ì	050	2	095	_	140	▶	197	ġ
006	í	051	3	096	'	141	F	198	Ɔ
007	ô	052	4	097	a	142	T	199	Ɔ
008	ó	053	5	098	b	143	↓	200	Ł
009	û	054	6	099	c	144	ç	201	J
010	ú	055	7	100	d	145	°	202	Ž
011	œ	056	8	101	e	146	ı	203	Đ
012	ú	057	9	102	f	147	ù	204	đ
013	ú	058	:	103	g	148	à	205	Č
014	ř	059	;	104	h	149	Æ	206	č
015	ó	060	<	105	i	150	ø	207	€
016	Λ	061	=	106	j	151	Å	208	Ɔ
017	Ψ	062	>	107	k	152	□	209	˘
018	Γ	063	?	108	l	153	é	210	è
019	˘	064	@	109	m	154	è	211	š
020	Ω	065	A	110	n	155	Pt	212	č
021	Δ	066	B	111	o	156	i	213	ž
022	Θ	067	C	112	p	157	Ñ	214	ý
023	Ξ	068	D	113	q	158	ò	215	ú
024	Π	069	E	114	r	159	£	216	ň
025	Σ	070	F	115	s	160	¥	217	˘
026	Υ	071	G	116	t	161	°	218	˘
027	Φ	072	H	117	u	162	Γ	219	ř
028	Ú	073	I	118	v	163	J	224	*
029	Ú	074	J	119	w	164	˘	225	§
030	Ö	075	K	120	x	165	.	226	Ø
031	Ó	076	L	121	y	177	Á	227	˘
032	(space)	077	M	122	z	178	Í	228	↑
033	!	078	N	123	{	180	Ā	229]
034	"	079	O	124		181	ā	230	[
035	#	080	P	125	}	182	Ē	231	"
036	\$	081	Q	126	β	183	ē	232	ä
037	%	082	R	127	¢	184	ī	233	ö
038	&	083	S	128	!!	185	î	234	ü
039	'	084	T	129	₁	186	ū	235	æ
040	(085	U	130	₂	187	ū	236	â
041)	086	V	131	₃	188	Ů	237	É
042	*	087	W	132	₄	189	ů	238	ñ
043	+	088	X	133	1/2	190	Č	253	*(DC)
044	,	089	Y	134	F _T	191	Š		
045	-	090	Z	135	←	192	Ç		

*(DC): Double-size character code

 : The shaded characters cannot be correctly displayed; a similar character or a space is displayed instead.

Note The character "!!" (code 128) cannot be displayed (displayed as "!").

AUXILIARY FUNCTION PROGRAMMING

1 Miscellaneous Key Programming

The cash register provides miscellaneous keys such as \ominus , %1, %2, EX, RA, RCPTPO, CH1, CH2, CR1, CR2 and TL/NS. Miscellaneous keys are programmed in one procedure with guidance messages except for the TL/NS key.

Note

- To keep current setting on each programming, press the #/TM/ST key when the corresponding guidance message is firstly displayed.
- When pressing the TL/NS key in the middle of procedure, the programming will terminate and the data you entered before the press of TL/NS is saved.
- When pressing the CL key twice in the middle of procedure, the programming will terminate and the data you entered before pressing the CL key twice is NOT saved.
- When pressing the department, PLU, \ominus , %1, %2, EX, RA, RCPTPO, CH1, CH2, CR1 or CR2 key in the middle of procedure except while entering texts or prices, the programming will move to the pressed key programming.

■ Programming for \ominus

	Key operation	Operator display
1. Specify the key to program.		
(1) Press the \ominus to enter \ominus programming. Immediately after displaying "(-) PROGRAMMING", guidance message for the next step will be displayed.	\ominus	<div style="border: 1px solid black; padding: 2px;">(-) PROGRAMMING</div> <div style="text-align: center;">↓</div> <div style="border: 1px solid black; padding: 2px;">ENTER [00] KEY</div>
2. Text programming (Press #/TM/ST to skip. / Press TL/NS to terminate.)		
(1) Press 00 key to enter text programming. Immediately after displaying guidance message, the current text data will be displayed.	00	<div style="border: 1px solid black; padding: 2px;">ENTER TEXT</div> <div style="text-align: center;">↓</div> <div style="border: 1px solid black; padding: 2px;">= (==)</div>
(2) Enter the text. A maximum of 16 characters can be entered. Please refer to "Guidance for text programming" on page 13 for entering the text. When you start entering a character, the current text data will be overwritten by new data. Pressing the \odot and \otimes key moves the cursor to the right and left respectively.	(-)	<div style="border: 1px solid black; padding: 2px;">(-)</div>
(3) Press the #/TM/ST key to register the text. Immediately after displaying guidance message for the next step, the current setting for the next step will be displayed.	#/TM/ST	<div style="border: 1px solid black; padding: 2px;">ENTER AMOUNT</div> <div style="text-align: center;">↓</div> <div style="border: 1px solid black; padding: 2px;">-0.00</div>
3. Amount programming (Press #/TM/ST to skip. / Press TL/NS to terminate.)		
(1) Enter the amount using numeric keys. A maximum of 6 digits can be set. Default setting is 0.	300	<div style="border: 1px solid black; padding: 2px;">300</div>

- (2) Press the **#/TM/ST** key to register the amount. Immediately after displaying guidance message for the next step, the current setting for the next step will be displayed.



4. Sign programming (Press **#/TM/ST** to skip. / Press **TL/NS** to terminate.)

- (1) Go to (2) when the sign does not need to be changed from "-". Otherwise, press **00** key to display "+".

Each time **00** key is pressed, the display shows "+" and "-" alternatively.

Choose "-" for discount and "+" for premium.

Default setting is "-".

- (2) Press the **#/TM/ST** key to register the setting. Immediately after displaying guidance message for the next step, the current setting for the next step will be displayed.

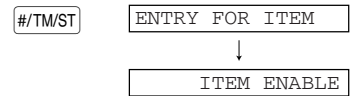

5. Discount calculation (for the items) programming (Press **#/TM/ST** to skip. / Press **TL/NS** to terminate.)

- (1) Go to (2) when the discount calculation for the items does not need to be changed from "ITEM ENABLE". Otherwise, press **00** key to display "ITEM DISABLE".

Each time **00** key is pressed, the display shows "ITEM DISABLE" and "ITEM ENABLE" alternatively.

Default setting is "ENABLE".

- (2) Press the **#/TM/ST** key to register the setting. Immediately after displaying guidance message for the next step, the current setting for the next step will be displayed.

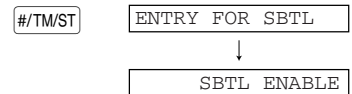

6. Discount calculation (for the subtotals) programming (Press **#/TM/ST** to skip. / Press **TL/NS** to terminate.)

- (1) Go to (2) when the discount calculation for the subtotals does not need to be changed from "SBTL ENABLE". Otherwise, press **00** key to display "SBTL DISABLE".

Each time **00** key is pressed, the display shows "SBTL DISABLE" and "SBTL ENABLE" alternatively.

Default setting is "ENABLE".

- (2) Press the **#/TM/ST** key to register the setting. Immediately after displaying guidance message for the next step, the current setting for the next step will be displayed.

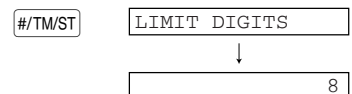

7. Entry digit limit programming (Press to skip. / Press to terminate.)

(1) Enter entry digit limit using numeric key.

7

The entry digit limit can be set up to 8.

Default setting is 8.

The entry digit limit is in effect for the REG mode operations but can be overridden in the MGR mode.

The entry digit limit is represented by the number of allowable digit for the maximum entry amount for discount key. When "0" is set, open price entry is prohibited.

(2) Press the key to register the setting.

8. Terminate programming

(1) Press the key to terminate the key programming.

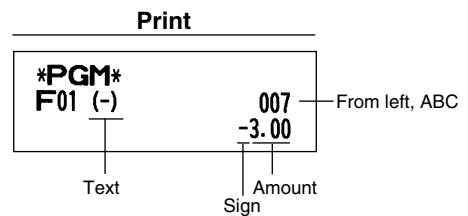

Item:	Selection:	Print:
A Discount calculation (for the items)	Enable*	0
	Disable	1
B Discount calculation (for the subtotals)	Enable*	0
	Disable	1
C Entry digit limit		0-8(default:8)

■ Programming for and

The key is used as an example below.

Key operation

Operator display

1. Specify the key to program.

(1) Press the key to enter programming.
 Immediately after displaying "%1 PROGRAMMING",
 guidance message for the next step will be displayed.



2. Text programming (Press to skip. / Press to terminate.)

(1) Press key to enter text programming.
 Immediately after displaying guidance message, the
 current text data will be displayed.



- (2) Enter the text.

A maximum of 16 characters can be entered.
Please refer to "Guidance for text programming" on page 13 for entering the text.
When you start entering a character, the current text data will be overwritten by new data.
Pressing the (•) and (⊗) key moves the cursor to the right and left respectively.

%

- (3) Press the
-
- key to register the text.

Immediately after displaying guidance message for the next step, the current setting for the next step will be displayed.

↓

3. Rate programming (Press to skip. / Press to terminate.)

- (1) Enter the rate using numeric keys, using a decimal point when setting fractional rates.
The rate can be set from 0.00 to 100.00.
Default setting is 0.

15.00

- (2) Press the
-
- key to register the rate.

Immediately after displaying guidance message for the next step, the current setting for the next step will be displayed.

↓

4. Sign programming (Press to skip. / Press to terminate.)

- (1) Go to (2) when the sign does not need to be changed from "-)". Otherwise, press (00) key to display "(+)".
Each time (00) key is pressed, the display shows "(+)" and "-)" alternatively.
Choose "-)" for discount and "(+)" for premium.
Default setting is "-)".

- (2) Press the
-
- key to register the setting.

Immediately after displaying guidance message for the next step, the current setting for the next step will be displayed.

↓

5. Discount calculation (for the items) programming (Press to skip. / Press to terminate.)

- (1) Go to (2) when the discount calculation for the items does not need to be changed from "ITEM ENABLE". Otherwise, press (00) key to display "ITEM DISABLE".
Each time (00) key is pressed, the display shows "ITEM DISABLE" and "ITEM ENABLE" alternatively.
Default setting is "ENABLE".

- (2) Press the
-
- key to register the setting.

Immediately after displaying guidance message for the next step, the current setting for the next step will be displayed.

↓

6. Discount calculation (for the subtotals) programming (Press to skip. / Press to terminate.)

(1) Go to (2) when the discount calculation for the subtotals does not need to be changed from "SBTL ENABLE". Otherwise, press key to display "SBTL DISABLE".

Each time key is pressed, the display shows "SBTL DISABLE" and "SBTL ENABLE" alternatively. Default setting is "ENABLE".

(2) Press the key to register the setting. Immediately after displaying guidance message for the next step, the current setting for the next step will be displayed.

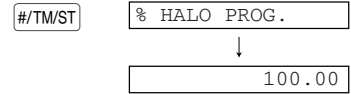

7. Percent rate limit programming (Press to skip. / Press to terminate.)

(1) Enter percent rate limit using numeric key. The rate limit can be set from 0.00 to 100.00. Default setting is 100.00.



(2) Press the key to register the setting. In the case of programming for the key, the display shows "%2 PROGRAMMING". Go to step 2 to program the key. In the case of programming for the key, the display shows "ENTER[TL/NS]KEY". Go to step 8.

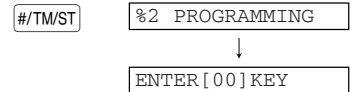

8. Terminate programming

(1) Press the key to terminate the key programming.

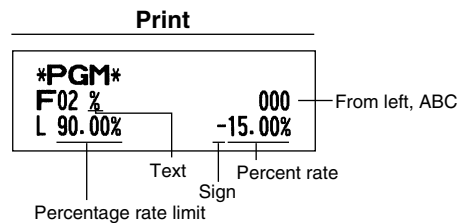
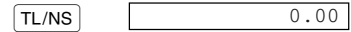

Item:	Selection:	Print:
A Discount calculation (for the items)	Enable*	0
	Disable	1
B Discount calculation (for the subtotals)	Enable*	0
	Disable	1
C Always 0 is printed.		0

■ Programming for EX

Key operation	Operator display
---------------	------------------

1. Specify the key to program.

- (1) Press the EX key to enter EX programming.
Immediately after displaying "EXCHANGE PROG.", guidance message for the next step will be displayed.

EX	EXCHANGE PROG.
	↓
	ENTER [00] KEY

2. Text programming (Press #/TM/ST to skip. / Press TL/NS to terminate.)

- (1) Press 00 key to enter text programming.
Immediately after displaying guidance message, the current text data will be displayed.

00	ENTER TEXT
	↓
	EXCH1

- (2) Enter the text.
A maximum of 16 characters can be entered.
Please refer to "Guidance for text programming" on page 13 for entering the text.
When you start entering a character, the current text data will be overwritten by new data.
Pressing the ◦ and ⊗ key moves the cursor to the right and left respectively.

EX	EX
----	----

- (3) Press the #/TM/ST key to register the text.
Immediately after displaying guidance message for the next step, the current setting for the next step will be displayed.

#/TM/ST	ENTER EX RATE
	↓
	0.000000

3. Rate programming (Press #/TM/ST to skip. / Press TL/NS to terminate.)

- (1) Enter the rate using numeric keys, using a decimal point when setting fractional rates.
The rate can be set from 0.000000 to 999.999999.
Default setting is 0.000000.

0.939938	0.939938
----------	----------

- (2) Press the #/TM/ST key to register the rate.
Immediately after displaying guidance message for the next step, the current setting for the next step will be displayed.

#/TM/ST	OPEN RATE ENTRY
	↓
	OPEN ENABLE

4. Open rate entry programming (Press #/TM/ST to skip. / Press TL/NS to terminate.)

- (1) Go to (2) when the open rate entry does not need to be changed from "OPEN ENABLE". Otherwise, press 00 key to display "OPEN DISABLE".
Each time 00 key is pressed, the display shows "OPEN DISABLE" and "OPEN ENABLE" alternatively.
Default setting is "ENABLE".

- (2) Press the #/TM/ST key to register the setting.
Immediately after displaying guidance message for the next step, the current setting for the next step will be displayed.

#/TM/ST	PRESET RATE
	↓
	PRESET ENABLE

5. Preset rate entry programming (Press to skip. / Press to terminate.)

- (1) Go to (2) when the preset rate entry does not need to be changed from "PRESET ENABLE".
 Otherwise, press key to display "PRESEST DISABLE".
 Each time key is pressed, the display shows "PRESET DISABLE" and "PRESET ENABLE" alternatively.
 Default setting is "ENABLE".

- (2) Press the key to register the setting.
 Immediately after displaying guidance message for the next step, the current setting for the next step will be displayed.

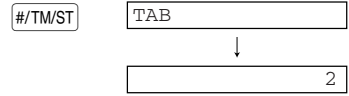

6. Position of decimal point programming (Press to skip. / Press to terminate.)

- (1) Enter the position of decimal point from right using numeric key.
 The position of decimal point from right can be set from 0 to 3.
 Default setting is 2.

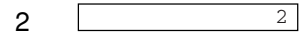

- (2) Press the key to register the setting.



7. Terminate programming

- (1) Press the key to terminate the key programming.

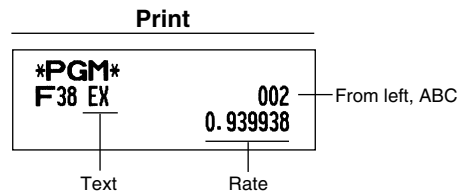

Item:	Selection:	Print:
A Open rate entry	Enable*	0
	Disable	1
B Preset rate entry	Enable*	0
	Disable	1
C TAB (position of decimal point from right)		0-3 (default:2)

Programming for , , , , and

The key is used as an example below.
 Programming for and , the step 3 and 4 are skipped.

Key operation Operator display

1. Specify the key to program.

- (1) Press the key to enter programming.
 Immediately after displaying "CH1 PROGRAMMING",
 guidance message for the next step will be displayed.

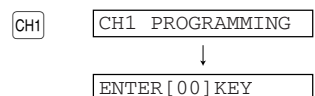

2. Text programming (Press to skip. / Press to terminate.)

- (1) Press key to enter text programming.
Immediately after displaying guidance message, the current text data will be displayed.

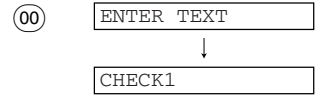

- (2) Enter the text.
A maximum of 16 characters can be entered.
Please refer to "Guidance for text programming" on page 13 for entering the text.
When you start entering a character, the current text data will be overwritten by new data.
Pressing the and key moves the cursor to the right and left respectively.

CHEQUE

- (3) Press the key to register the text.
Immediately after displaying guidance message for the next step, the current setting for the next step will be displayed.

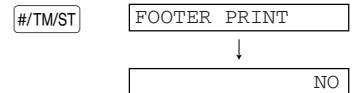

3. Footer print on receipt programming (Press to skip. / Press to terminate.)

- (1) Go to (2) when the footer print on receipt does not need to be changed from "NO". Otherwise, press key to display "YES".
Each time key is pressed, the display shows "YES" and "NO" alternatively.
Default setting is "NO".
This programming decides whether or not the machine should print a message at the foot of a receipt when a specified key is used. With regard to programming method of footer logo message, refer to "Logo messages" section on page 23.

- (2) Press the key to register the setting.
Immediately after displaying guidance message for the next step, the current setting for the next step will be displayed.

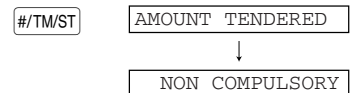

4. Entry of amount tendered programming (Press to skip. / Press to terminate.)

- (1) Go to (2) when the entry of amount tendered does not need to be changed from "NON COMPULSORY". Otherwise, press key to display "COMPULSORY".
Each time key is pressed, the display shows "COMPULSORY" and "NON COMPULSORY" alternatively. In case of and programming, "INHIBIT" is displayed instead of "NON COMPULSORY".
Default setting is "NON COMPULSORY" or "INHIBIT".

- (2) Press the key to register the setting.
Immediately after displaying guidance message for the next step, the current setting for the next step will be displayed.

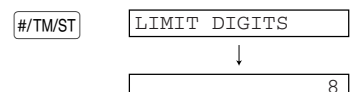

5. Entry digit limit programming (Press **#/TM/ST** to skip. / Press **TL/NS** to terminate.)

(1) Enter entry digit limit using numeric key.
The entry digit limit can be set up to 8.
Default setting is 8.

7

The entry digit limit is in effect for REG mode operation but can be overridden in the MGR mode. The entry digit limit is represented by the number of allowable digits for the maximum entry or total amount. When "0" is set, the operation of the corresponding key is prohibited.

(2) Press the **#/TM/ST** key to register the setting.
In the case of programming for the **CH1** and **CR1** keys, the display shows "CH2 PROGRAMMING" and "CR2 PROGRAMMING" respectively. Go to step 2 to program the **CH2** and **CR2** keys.
In the case of programming for the **RA**, **ROPT/PO**, **CH2** and **CR2** keys, the display shows "ENTER[TL/NS]KEY". Go to step 6.

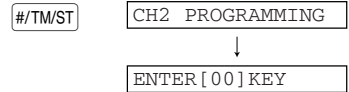

6. Terminate programming

(1) Press the **TL/NS** key to terminate the **CH1** key programming.

TL/NS

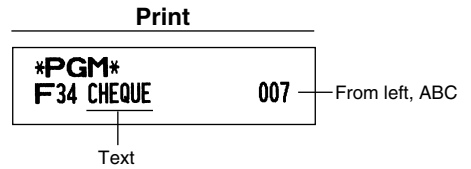

Item:	Selection:	Print:
A Footer print	No*	0
	Yes	1
B Amount tendered entry	Non compulsory (for CH1 and CH2)*	0
	Inhibit (for CR1 and CR2)*	0
	Compulsory	1
C Entry digit limit		0-8 (default:8)

Function parameters for **TL/NS**

Procedure

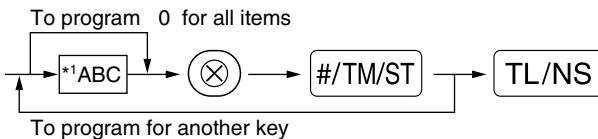

*1:Item:	Selection:	Entry:
A Footer printing*	Allow	1
	Disallow*	0
B Amount tendered entry*	Compulsory	1
	Non-compulsory*	0
C Entry digit limit		0-8 (default:8)

Footer printing

- This programming decides whether or not the machine should print a message at the foot of a receipt when the [TL/NS] key is used. With regard to programming method of footer logo message, refer to “Logo messages” section on page 23.

Amount tendered entry

- You may select amount tendered, compulsory or optional.

Entry digit limit

- Program upper limit entry for total cash amount which can be handled on the register. The entry digit limit is in effect for REG mode operation but can be overridden in the MGR mode. The entry digit limit is represented by the number of allowable digits for the maximum entry or total amount. When “0” is set, the operation of the corresponding key is prohibited.

Key operation example	Print

2 Other Text Programming

Please refer to “Guidance for text programming” on page 13 as for how to entering characters.

Foreign currency symbol (4 digits)

Foreign currency symbol for the [EX] key is printed with a foreign currency exchange amount obtained using a preset rate.

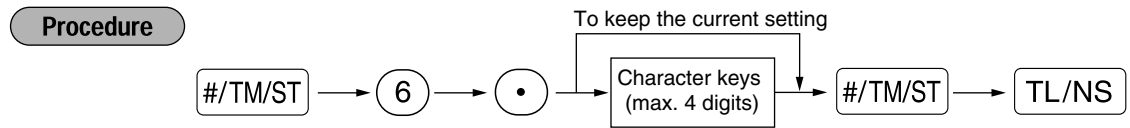

Key operation example	Print

Domestic currency symbol (4 digits)

“*” is set as a default setting. When you want to change the domestic currency symbol, change the setting.

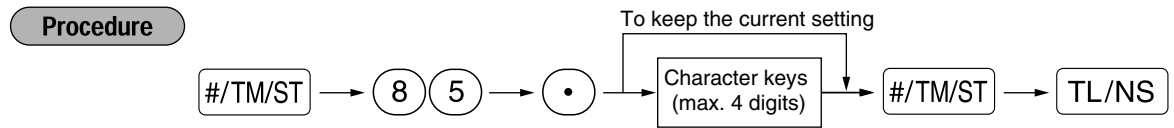

Key operation example	Print

■ Training mode text (12 digits)

For every receipts issued in the training mode, ****TRAINING**** is printed by default. When you want to change the text, follow the procedure below.

Procedure

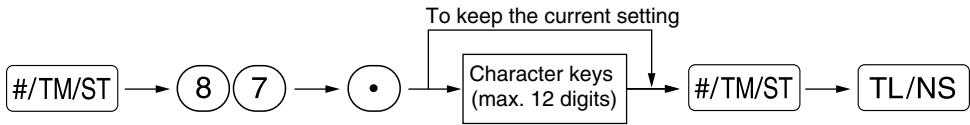

Key operation example



Print



Note

The programmed text is printed in double-size characters on the receipts issued in the training mode.

■ Function text (12 digits)

Procedure

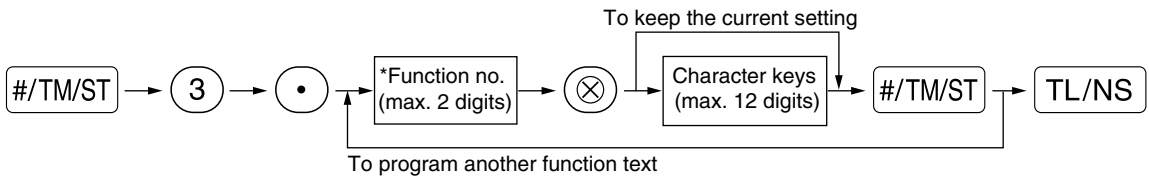

* Function no.: See "List of function texts" shown on the following page.

Key operation example

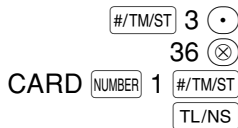

Print



(Programming CARD1 for credit 1)

■ List of function texts

Function no.	Key or function	Default setting	Function no.	Key or function	Default setting
1	⊖	(-)	41	Exchange credit	EX1 CR
2	%1	%1	42	Cash in drawer	**** CID
3	%2	%2	43	Cash/cheque in drawer	CA/CH ID
4	Differ	DIFFER	44	Change for cheque	CHK/CG
5	Taxable 1 subtotal	TAX1 ST	45	Domestic currency 1	DOM.CUR1
6	Taxable 2 subtotal	TAX2 ST	46	Domestic currency 2	DOM.CUR2
7	Taxable 3 subtotal	TAX3 ST	47	Dom. currency for EX cheque	DOM.CUR1
8	Taxable 4 subtotal	TAX4 ST	48	Dom. currency for EX credit	DOM.CUR1
9	VAT/tax 1	VAT 1	49	Cheque in drawer	*CH ID
10	VAT/tax 2	VAT 2	50	(+) Dept total	*DEPT TL
11	VAT/tax 3	VAT 3	51	(-) Dept total	DEPT (-)
12	VAT/tax 4	VAT 4	52	Net 1 (Taxable 1 - VAT/tax 1)	NET 1
13	Net 1	NET1	53	Net 2 (Taxable 2 - VAT/tax 2)	NET 2
16	Net 2	NET2	54	Net 3 (Taxable 3 - VAT/tax 3)	NET 3
17	Refund	REFUND	55	Net 4 (Taxable 4 - VAT/tax 4)	NET 4
18	Void	∞	56	Subtotal	SUBTOTAL
19	Void mode total	∞ MODE	57	Merchandise subtotal	MDSE ST
20	Manager void	MGR ∞	58	Total	*** TOTAL
21	Subtotal void	SBTL ∞	59	Change	CHANGE
22	Bill counter	BILL CNT	60	Sales q'ty	ITEMS
23	No sale	NO SALE	61	Due	DUE
26	Customer	GUEST	62	Exchange (Preset rate) change	EX1 CHG
28	Paid total	PAID TL	63	Amount	AMOUNT
29	Average	AVE.	64	Total tax	TTL TAX
31	RA	***RA	67	Net without tax (on report)	NET
32	PO	***PO	68	Department report title	DEPT
33	Cash	CASH	69	PLU report title	PLU
34	Cheque 1	CHECK1	70	Transaction report title	TRANS.
35	Cheque 2	CHECK2	71	Clerk report title	CLERK
36	Credit 1	CREDIT1	72	Hourly report title	HOURLY
37	Credit 2	CREDIT2	76	Non add symbol (8 chara.)	#
38	Exchange (Preset rate)	EXCH1	77	Copy receipt title	COPY
39	Exchange (Open rate)	EXCH2	79	EJ report title	EJ
40	Exchange cheque	EX1 CHK	80	EJ report end title	EJ END

ADVANCED FUNCTION PROGRAMMING

1 Register Number and Consecutive Number Programming

The register number and consecutive numbers are printed on every receipt or journal. When your store has two or more registers, it is practical to set separate register numbers for identification. The consecutive number is increased by one each time a receipt is issued or when a journal print occurs. For consecutive number programming, enter a number (max. 6 digits) that is one less than the desired starting number.

Register number

Procedure

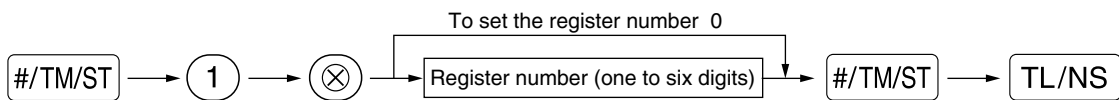

Key operation example

123456 1
 TL/NS

Print

```
*PGM*  
#1      123456 — Register number
```

Consecutive number

Procedure

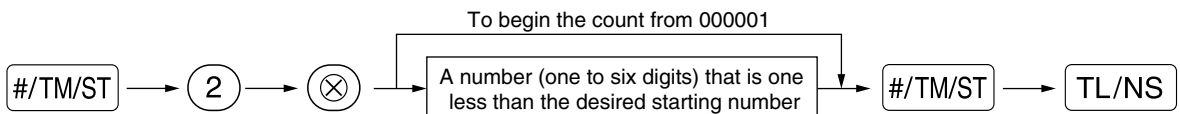

Key operation example

1000 2
 TL/NS

Print

```
*PGM*  
#2      001000 — Consecutive number
```

2 Various Function Selection Programming 1

The cash register provides various detailed functions listed below.

- Function selection for miscellaneous keys
- Print format
- Receipt print format
- Others

For this programming, the job code entry style is applied. You can continue programming until you press the **TL/NS** key for the programming described in this section. To continue programming, repeat from a job code entry.

Procedure

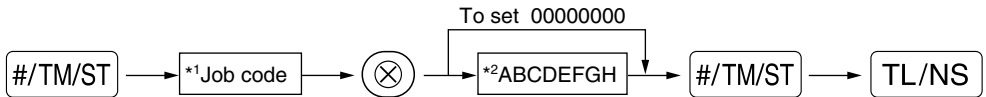

*1 Enter job code using numeric keys specified in each section below.

*2 Data entry details are listed on each table in each section below. An asterisk is entered for factory setting.

Example: When programming for job code 5 as ABCDEFGH: 00000100.

Key operation example

00000100 #/TM/ST 5 ⊗
#/TM/ST TL/NS

Print

```

*PGM*
#5 00000100
  
```

Function selection for miscellaneous keys

Job code: 5

* Item:	Selection:	Entry:
A Paid-out in the REG mode	Enable*	0
	Disable	1
B Received on account in the REG mode	Enable*	0
	Disable	1
C Subtotal void in the REG mode	Enable*	0
	Disable	1
D Indirect void in the REG mode	Enable*	0
	Disable	1
E Direct void in the REG mode	Enable*	0
	Disable	1
F Refund entry in the REG mode	Enable*	0
	Disable	1
G No sale in the REG mode	Enable*	0
	Disable	1
H Fractional quantity entry	Enable (3 digits decimal place)	0
	Disable*	1

■ Print format

Job code: 6

* Item:	Selection:	Entry:
A	Printing style	Journal printing
		Receipt*
B	Receipt print style	Total
		Detailed*
C	Time print on all receipts	Yes*
		No
D	Date print on all receipts	Yes*
		No
E	Consecutive no. print	Yes*
		No
F	Separator line in reports	One line space
		Separator line*
G	Zero skip in PLU report	No
		Yes*
H	Zero skip in full sales/clerk/hourly reports	No
		Yes*

Printing style

- Even when receipt printing is selected, the journal rewind motor will be driven in PGM, OP X/Z, X1/Z1 and X2/Z2 modes so you can wind sales and programming reports.

■ Receipt print format

Job code: 7

* Item:	Selection:	Entry:
A	Always enter 0.	0
B	Always enter 0.	0
C	Subtotal print with a press of subtotal key	No*
		Yes
D	Always enter 0.	0
E	VAT/tax amount print	Yes*
		No
F	Taxable amount print	Yes*
		No
G	Net amount print	Yes*
		No
H	Purchase no. print	Yes*
		No

Other programming

Note As the guidance messages for other programming, "OTHERS + the lower digit number of job code" is displayed. For example, for job code 61, "OTHERS 1" is displayed as the guidance message.

Job code: 61

* Item:	Selection:	Entry:
A	Always enter 0.	0
B	Always enter 0.	0
C	Negative dept. and PLU/subdept.	Disable
		Enable*
D	Fractional treatment	Round off (4 down, 5 up)*
		Raising to unit
		Disregarding fractional treatment
E	Use of (00) key	As 00 key*
		As 000 key
F	Time format	12-hour format
		24-hour format*
G	Date format	Use month-day-year format
		Use day-month-year format*
		Use year-month-day format
H	Position of decimal point (from right) (TAB)	0 to 3 (default: 2)

Job code: 62

* Item:	Selection:	Entry:
A	Always enter 0.	0
B	Error beep for misoperation	Lock error
		Misoperation*
C	Key catch sound	Yes*
		No
D	Buffered keyboard	Yes*
		No
E	Void mode	Enable*
		Disable
F	Printing of void mode in X2/Z2 report	Yes*
		No
G	Printing of void mode in X1/Z1 report	Yes*
		No
H	Addition to the hourly total in VOID mode	No*
		Yes

Job code: 63

* Item:	Selection:	Entry:
A Receipting at the time of "no sale" entry	Yes*	0
	No	1
B No sale after non-add code entry	Disable	0
	Enable*	1
C Non-add code entry	Enable*	0
	Disable	1
D Copy receipt	No*	0
	Yes	1
E Entry that causes the merchandise subtotal to be smaller than zero	Enable*	0
	Disable	1
F Subtotal entry before tendering	Noncompulsory*	0
	Compulsory	1
G Subtotal entry before direct non-tender finalization	Noncompulsory*	0
	Compulsory	1
H Direct non-tender finalization after tendering	Disable	0
	Enable*	1

Job code: 64

* Item:	Selection:	Entry:
A Printing of GT1 on Z report	Yes*	0
	No	1
B Printing of GT2 on Z report	Yes*	0
	No	1
C Printing of GT3 on Z report	Yes*	0
	No	1
D Printing of Training GT on Z report	Yes*	0
	No	1
E Printing of Z counter on Z report	Yes*	0
	No	1
F Printing of DATA on PLU resetting report	Yes*	0
	No	1
G Resetting of GT1, 2, 3 at the general Z1 report	No*	0
	Yes	1
H OP X/Z report	Enable*	0
	Disable	1

Job code: 66

* Item:	Selection:	Entry:
A After transaction receipt	Total only	0
	Details*	1
B Amount printing when PLU unit price is zero	No*	0
	Yes	1
C Conversion SBTL printing of native SBTL	Yes*	0
	No	1
D VAT/tax assignment print	Yes	0
	No*	1
E Compression print on journal at PGM, X1/Z1 and X2/Z2 modes	No (normal size)	0
	Yes (small size)*	1
F Compression print on journal at REG, MGR and VOID modes	No (normal size)	0
	Yes (small size)*	1
G Logo text print on journal	No*	0
	Yes	1
H Footer print control	All receipts*	0
	Only on selected function key at the time of finalization	1

Compression print on journal

- This selection is valid when “printing style” (job code 6) is set to “journal printing”.

Job code: 67

* Item:	Selection:	Entry:
A Rounding amount printing	No*	0
	Yes (for Australian system)	1
B Total amount rounding when a transaction is finalized directly by <input type="checkbox"/> CH1, <input type="checkbox"/> CH2, <input type="checkbox"/> CR1 or <input type="checkbox"/> CR2 key	Rounding*	0
	Not rounding (for Australian system)	1
C Rounding up of the unit digit of amount		0 - 9 (default: 0)
D Rounding down of the unit digit of amount		0 - 9 (default: 0)
E Application of rounding	Item and payment*	0
	Payment	1
F Limit of the least significant digit in entering amount of item	Arbitrary*	0
	0 only	1
	0 and 5 only	2
G Memory of difference due to rounding	No*	0
	Yes	1
H Limit of the least significant digit in entering amount of payment	Arbitrary*	0
	0 only	1
	0 and 5 only	2

Rounding amount printing (A)

Total amount rounding when a transaction is finalized directly by CH1, CH2, CR1 or CR2 key(B)

- When you live in Australia, set as shown on the table below for the parameters A and B.

Rounding up of the unit digit of amount (C)

Rounding down of the unit digit of amount (D)

- Handle C and D as a pair. When you live in Australia, Switzerland, Norway or South Africa, set as shown on the table below for the parameters C and D.

The rounding is performed as follows:

In case C = 0: Unit digit of amount < or = Value of D — rounding down

Value of D < or = Unit digit of amount — rounding to 5

In other cases: Unit digit of amount < or = Value of D — rounding down

Value of D < Unit digit of amount < Value of C — rounding to 5

Value of C < or = Unit digit of amount — rounding up

Application of rounding (E)

Limit of the least significant digit in entering amount of item (F)

Memory of difference due to rounding (G)

Limit of the least significant digit in entering amount of payment (H)

- When you live in Australia, Switzerland, Norway or South Africa, set as shown on the table below for the parameters E through H.

	CD	E	F	G	H
Switzerland	82	Item & payment	0 and 5 only	No	0 and 5 only
Norway	54	Payment	Arbitrary	Yes	0 only
South Africa	05	Payment	Arbitrary	Yes	0 and 5 only

	A	B	CD	E	F	G	H
Australia	Yes	Not rounding	82	Payment*	Arbitrary	Yes	0 and 5 only

* Applied to payment by cash and change amount.

Job code: 68

* Item:	Selection:	Entry:
A Always enter 0.		0
B Always enter 0.		0
C Temporary EJ printing during a transaction	Disable	0
	Enable*	1
D EJ printing and clearing EJ data when issuing general Z1 report	No*	0
	Yes	1
E PGM mode operation records type	Details*	0
	Header information only	1
F REG/MGR/VOID modes operation records type	Details*	0
	Total	1
G Compressing printing for EJ data	No (normal size)	0
	Yes (small size)*	1
H Action when EJ memory area is full	Continue	0
	Continue and warning (near full warning)*	1
	Lock and warning (with near full warning)	2

Temporary EJ printing during a transaction

- If selecting "enable", you can print journal data of a current transaction recorded in EJ memory by pressing the **RCPT/PO** key during the transaction. To realize this function completely, the cash register must be programmed to print the receipt and set the Receipt ON/OFF function to OFF.

PGM mode operation records type

- The header information only is printed during the program reading operation. The header information only is printed for X/Z reports.

(Receipt sample for Header Information only)

```
22/05/2007 123456#001104
8:21 01 CLERK 01
**X1*
* DEPT *
*TRANS.*
```

Action when EJ memory area is full

- By default, when the memory for EJ becomes nearly full, the cash register shows "EJ NEAR FULL", and the cash register keeps storing new data while erasing the oldest data. When "0" is selected, the cash register will no longer show EJ memory nearly full message. When "2" is selected, the cash register shows EJ memory nearly full message and when the memory is totally full, the cash register locks the sales/data entry with a display of the memory full message "EJ DATA FULL". You must issue an EJ report (Z1 report) at this time.

Job code: 69

* Item:	Selection:	Entry:
A	Always enter 0.	0
B	Always enter 0.	0
C	Always enter 0.	0
D	Rounding of foreign currency for EX	
	Rising to unit*	0
E	Round off (4 down/5 up)	1
	Tax system	
	Auto tax 1-4	0
	Auto VAT 1-4*	1
	Manual VAT 1-4	2
	Manual VAT 1	3
F	Manual tax 1-4	4
	Tax print when taxable subtotal is zero	
	No*	0
G	Yes	1
	Tax print when tax is zero	
H	Yes*	0
	No	1
	Rounding system	
	Normal*	0
	Sweden	1
	Denmark	2

Rounding system

- When you live in Sweden or Denmark, change the default setting (H=0) to the corresponding setting.

3 Various Function Selection Programming 2

The cash register provides various options so you can use the register to suit your sales needs. In this section, you can program the following features (parameters within parentheses indicate default setting):

- Power save mode (entering the power save mode after 30 minutes)
- Logo message print format (Header 6-line message)
- Thermal printer density (standard density)
- EJ memory type (EJ 9000 records and PLU 210 codes)
- Training clerk specification (none) - If you specify a clerk number who is trained for use on this cash register, the cash register will go into training mode when the clerk is signed on for sales entries. The sales operations done by the trained clerk do not affect sales totals. For details, refer to TRAINING MODE section.

Power save mode

Procedure

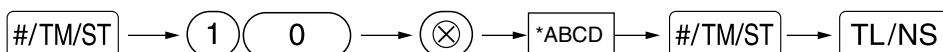

* Item:	Selection:	Entry:
A Entering power save mode when time is displayed	Yes*	0
	No	1
B-D Time(min.) to entering power save mode since no operation is made		001-254 or 999 (Default 030)

Note

When 999 is set for B to D, entering into power save mode is inhibited.

Key operation example



Print

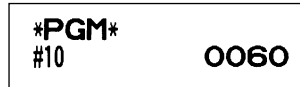

Logo message print format

You can select the number of lines for your logo message, and the position to print it on receipt. For details of the logo message type, please refer to "Logo messages" on page 23.

Procedure

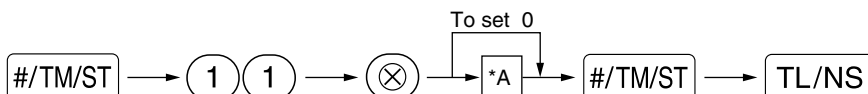

- *A: Logo message type
- 0: Header 3-line message without graphic logo
 - 3: Header 6-line message
 - 5: Header 3-line message and footer 3-line message (default)

Key operation example

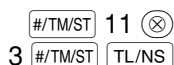

Print

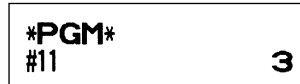

Thermal printer density

Procedure

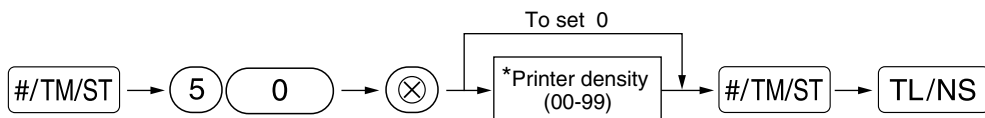

* 50 (100%) is the default setting. To make the print darker, set a larger number, and to make the print lighter, set a smaller number.

Key operation example

#/TM/ST 50 (X)
70 #/TM/ST TL/NS

Print

PGM
#50 70

EJ memory type

Caution

When this procedure is executed, EJ data is cleared, and PLU data (programming data and sales data) are reset to the default after all data is cleared even if the same memory type is selected.

Procedure

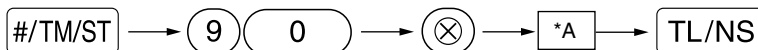

*A: 0 for EJ 8000 lines and PLU 1200 codes
1 for EJ 9000 lines and PLU 210 codes (default)

Key operation example

#/TM/ST 90 (X)
0 TL/NS

Print

PGM
#90 0

Training clerk specification for training mode

For the details of clerk training, please refer to "TRAINING MODE" on page 73.

Procedure

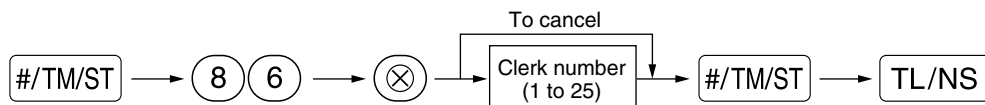

Key operation example

#/TM/ST 86 (X)
20 #/TM/ST TL/NS

Print

PGM
#86 20

■ AUTO key programming — Automatic sequence key

If you program frequently performed transactions or report sequences for the **AUTO** key, you can recall those transactions and/or reports simply by pressing the **AUTO** key in key operations.

Procedure

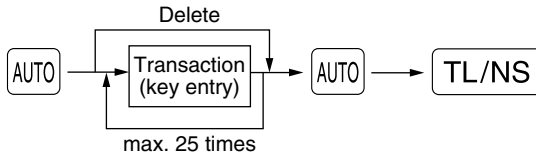

Programming for **AUTO**; entering a PLU 2 item and a dept. 6 item (unit price: 1.00)

Key operation example

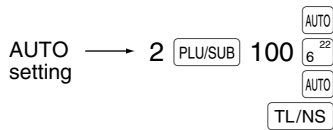

Print

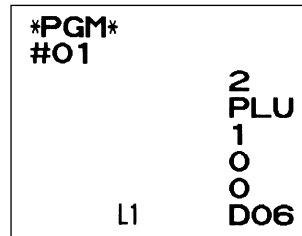

Note

When the **AUTO** key has been programmed to execute a report job function, the mode switch must be in the appropriate position (*OPX/Z* for individual clerk reports, *X1/Z1* for daily reports or *X2/Z2* for weekly or monthly reports).

4 EURO Programming

For details of EURO migration operation, please refer to “EURO MIGRATION FUNCTION”.

■ EURO system settings

Procedure

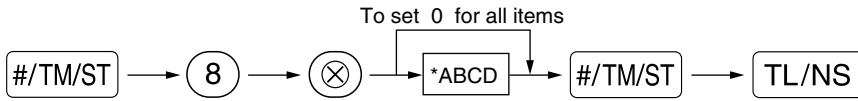

* Item:	Selection:	Entry:
A Printing exchange total amount and change amount on receipt or journal	No*	0
	Yes	1
B Always enter 0.		0
C Cheque and credit operation when tendering in foreign currency	No*	0
	Yes	1
D Exchange calculation method	Multiplication*	0
	Division	1

Printing exchange total amount and change amount on receipt/journal

- Total and change amounts in exchange currency are printed respectively below each of the total and exchange amounts in domestic currency.

Exchange calculation method

- “Division” or “Multiplication” can be selected for the conversion method from domestic currency to exchange currency, and the calculation is performed as follows:

In case that “Division” is selected:

$$\text{Domestic currency amount} \div \text{Exchange rate} = \text{Exchange amount}$$

In case that “Multiplication” is selected

$$\text{Domestic currency amount} \times \text{Exchange rate} = \text{Exchange amount}$$

Key operation example

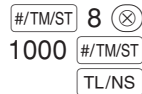

Print

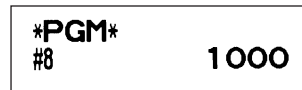

■ Automatic EURO modification operation settings

Procedure

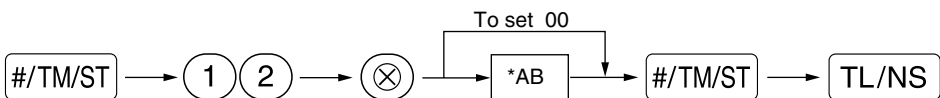

* Item:	Selection:	Entry:
A Converting the preset unit price of Dept./PLU in the automatic modification operation for EURO (job #800 in the X2/Z2 mode)	Yes*	0
	No	1
B Automatic modification operation for EURO (job #800 in the X2/Z2 mode) at the preset date	Compulsory*	0
	Non-compulsory	1

Key operation example

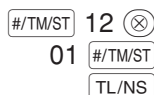

Print

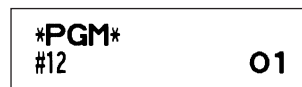

Note If you have already made the Job #800 operation with the substitution of 3 for “A” in the X2/Z2 mode, this programming is disabled.

■ Date setting for EURO modification operation

Procedure

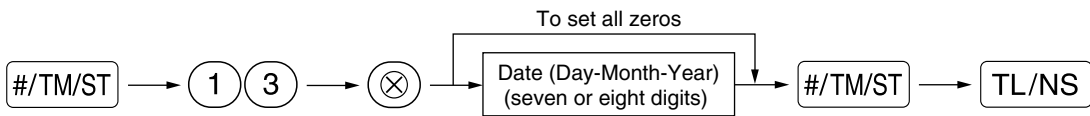

Key operation example

```

#/TM/ST 13 ⊗
01072009 #/TM/ST
          TL/NS
    
```

Print

```

*PGM*
#13      01/07/2009
    
```

Note

- In case you changed the date format using job code 61, follow the format you selected for setting the date.
- If all zeros are set, this programming is disabled.
- If you have already made the Job #800 operation with the substitution of 3 for "A" in the X2/Z2 mode, this programming is disabled.

■ Time setting for EURO modification operation

Procedure

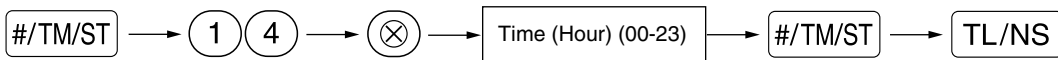

Key operation example

```

#/TM/ST 14 ⊗
10      #/TM/ST
        TL/NS
    
```

Print

```

*PGM*
#14      10:00
    
```

Note

- If you have already made the Job #800 operation with the substitution of 3 for "A" in the X2/Z2 mode, this programming is disabled.

5 Reading Stored Programs

The machine allows you to read every program stored in the PGM mode.

■ Key sequence for reading stored program

Report name	Key sequence
Programming report 1	TL/NS
Programming report 2	2 → TL/NS
Auto key programming report	1 → TL/NS
Printer density programming report	3 → TL/NS
Department programming report	4 → TL/NS
PLU programming report	Start PLU code → ⊗ → End PLU code → PLU/SUB

Note

To stop reading programming report, turn the mode switch to the MGR position.

Sample printouts

1 Programming report 1

PGM		Mode
F01 (-)	007	Function no. & its text
	-3.00	Function parameters
F02 %	000	Discount amt. w/sign
L 90.00%	-15.00%	Function parameters
F03 %2	000	Percent rate with sign
L100.00%	-0.00%	Percent limit
F04 DIFFER		
F05 TAX1 ST		
F06 TAX2 ST		
F07 TAX3 ST		
F08 TAX4 ST		
F09 VAT 1		
F10 VAT 2		
F11 VAT 3		
F12 VAT 4		
F13 NET1		
F16 NET2		
F17 REFUND		
F18 ∞		
F19 ∞ MODE		
F20 MGR ∞		
F21 SBTL ∞		
F23 NO SALE		
F26 GUEST		
F28 PAID TL		
F29 AVE.		
F31 ***RA	9	Entry digit limit
F32 ***PO	9	
F33 CASH	018	Function parameters (A-C)
F34 CHEQUE	007	
F35 CHECK2	008	
F36 CARD1	008	
F37 CREDIT2	008	
F38 EX	002	
US \$	0.939938	Foreign currency symbol/Rate
F39 EXCH2		

F77	COPY	
F79	EJ	
F80	EJ END	
	SHARP	Logo Message
	PRESENTS THE	
	BEST ECR	
	SHARP	
	IS	
	THE BEST	
#5	00000100	Function selection for miscellaneous keys (A-H)
#6	11000111	Print format (A-H)
#7	00000000	Receipt print format(A-H)
#8	1000	EURO system settings (A-D)
#10	0060	Power save mode(A-D)
#11	3	Logo message print format
#12	01	Automatic EURO modification operation settings (AB)
#13	01/07/2009	Date setting for EURO modification operation
#14	10:00	Date setting for EURO modification operation
#15	00011010	Time setting for EURO modification operation
#35	007	Time setting for EURO modification operation
T1	16.0000%	*Job code #15 and #35 are fixed settings, for which you cannot change the settings.
	0.00	
T2	7.0000%	Tax rate
	0.00	Min. taxable amount
T3	-----	
T4	-----	
C#01	DAVID	Clerk name/code
C#02	CLERK 02	
C#24	CLERK 24	
C#25	CLERK 25	

2 Programming report 2

PGM		
#61	00100112	Job code
#62	01000000	
#63	01000001	A to H from the left
#64	00000000	* Job code #65, 70, 71, 72, 76 and 77 are fixed settings, for which you cannot change the settings.
#65	10000000	
#66	10011100	
#67	10000010	
#68	00100011	
#69	00001000	
#70	10000000	
#71		
GT2	€00000000870.83	
#72		
GT3	-00000000176.95	
#76	Z1 0000	
#77	Z2 0000	
#85	€	Domestic currency symbol
#86	20	Training clerk specification
#87	TRAINING	Training mode text
#88	0	Language selection
#90	1	EJ memory type

5 Department programming report

PGM				
Dept. code	D01	T1	083	Dept. function
Dept. text	FRUIT		10.00	Dept. unit price w/sign
	D02	T1	183	
	DEPT. 02		-13.10	Minus department
	D03	T1	083	
	DEPT. 03		1.50	Tax status

DEPT. 97		0.00
D98	T1	081
DEPT. 98		0.00
D99	T1	081
DEPT. 99		0.00

6 PLU programming report

PGM		0001-0015	Range
PLU code	P0001(03)	0	Mode parameter
PLU text	MELON	1.25	Unit price
	P0002(01)	1	
	PLU. 0002	2.15	
	P0003(32)	1	
	PLU. 0003	-0.15	Associated dept. code

PLU. 0014	1.00
P0015(01)	1
PLU. 0015	1.50

3 Auto key programming report

PGM	
#01	
	2
	PLU
	1
	0
	0
L1	D06

4 Printer density programming report

PGM		
#50	70	Entered value Printer density
10	: 0123456789AB	
20	: 0123456789AB	
30	: 0123456789AB	
40	: 0123456789AB	
50	: 0123456789AB	
60	: 0123456789AB	
70	: 0123456789AB	
80	: 0123456789AB	
90	: 0123456789AB	

Printing density example

TRAINING MODE





The training mode is used when the operator or the manager practices register operations.

When a clerk in training is selected, the machine automatically enters the training mode. To specify a clerk to be trained, refer to "Training clerk specification for training mode" in "ADVANCED FUNCTION PROGRAMMING" in page 67.

The training operation is valid only in REG, MGR and  mode.

The corresponding clerk memory is only updated in the training mode.

Key operation example

A clerk set in training → 20 
 1000 
 3 

 TL/NS

Print

22/05/2007 123456#000440
 10:24 20 CLERK 20

****TRAINING****
 DEPT. 05 *10.00
3x 24.00
 DEPT. 03 *72.00

ITEMS 4Q
CASH *82.00

READING (X) AND RESETTING (Z) OF SALES TOTALS































- Use the reading function (X) when you need to take a reading of sales information entered since the last reset. You can take this reading any number of times. It does not affect the register's memory.
- Use the resetting function (Z) when you need to clear the register's memory. Resetting prints all sales information and clears the entire memory except for the GT1 through GT3, Training GT, BAL, reset count, and consecutive number.

1 Summary of Reading (X) and Resetting (Z) Reports

X1 and Z1 reports: Daily sales reports

X2 and Z2 reports: Periodic (monthly) consolidation reports

When you take an X or Z report, turn the mode switch to the appropriate position referring to the column of "Mode switch position" shown on the table below, and use the following corresponding key sequence.

Item	Mode switch position			Key operation
	OPX/Z	X1/Z1	X2/Z2	
Flash report: (Only display) To clear the display, press the  key or turn the mode switch to another position.	X	—	—	Dept. code →  : Department sales total [For dept. 1 to 16: Dept. key ( to ) For dept. 17 to 32:  → Dept. key ( to )]  key: Amount of cash in drawer  key: Sales total
Full sales report	—	X1, Z1	X2, Z2	Reading:  Resetting:  → 
PLU report by designated range	—	X1, Z1	—	Reading:  →  →  →  (All PLUs) Resetting:  →  →  →  →  (All PLUs)
Individual clerk report	X, Z	—	—	Reading:  Resetting:  →  (The report of the current clerk)
Full clerk report	—	X1, Z1	—	Reading:  Resetting:  → 
Hourly report	—	X1, Z1	—	Reading:  Resetting:  → 

Note

- When both sales quantities and sales amounts are zero, printing is skipped. If you do not want to skip, change the programming. (Refer to "Print format" of "Various Function Selection Programming 1".)
- "X" represents read symbol and "Z" represents reset symbol in the reports.
- To stop reading and resetting the PLU sales report, turn the mode switch to the MGR position. The data will not be erased when you reset.
- The drawer does not open when you take X/Z reports.
The drawer can be opened by pressing the  key to remove the till after closing your business.
- When printing is performed continuously, the printing may be intermitted several seconds. After the intermission, the printing will be restarted.

2 Daily Sales Totals

For the sample reports of the full sales and periodic consolidation report, refer to "FULL SALES REPORT (Z REPORT)" on page 30.

■ PLU report by designated range

• Sample report

PLU code	Item label	Mode title*	Report title	Range	Sales q'ty and total	
		X1	* PLU *	0001-0015		
P0001				19 Q		
PLU.0001					*29.83	
P0002				21 Q		
PLU.0002					*31.50	
P0010				4 Q		
PLU.0010					*28.60	
P0011				11 Q		
PLU.0011					*99.30	
P0012				8 Q		
PLU.0012					*18.88	
P0013				-7 Q		
PLU.0013					-14.70	
P0015				1 Q		
PLU.0015					*5.75	
***TOTAL					57 Q	*199.16

■ Individual clerk report

• Sample report

Mode title*	Report title	Clerk code	Clerk name	Paid total	Average	Customer counter
OPX	* CLERK *	O1#	DAVID			
		PAID TL		*2005.73		
		AVE.		*28.65		
		GUEST	70 Q			

		∞	8 Q		*36.88	
		∞ MODE	1 Q		*11.50	
		MGR ∞	2 Q		*11.50	
		SBTL ∞	1 Q		*60.90	

		EXCH1	2 Q			
				US \$200.00		
		DOM. CUR1		*212.76		
		EXCH2	2 Q			
				188.62		
		DOM. CUR2		*147.92		
		***CID		*1473.55		
		*CH ID		*20.00		
		CA/CH ID		*1493.55		

■ Hourly report

• Sample report

Mode title*	Report title	Customer counter	Sales total
X1	*HOURLY*		
		10:00	12 Q
			*119.98
		11:00	18 Q
			*186.89
		12:00	25 Q
			*199.91
		13:00	7 Q

		17:00	18 Q
			*126.69
		18:00	16 Q
			*92.26

■ Full clerk report

The printout occurs in the same format as in the sample report of individual clerk, but all clerk's sales data and total of all clerks are printed in the order of clerk number (from #1 to #25).

*: When you take Z1 report, "Z1" is printed.

EJ REPORT READING AND RESETTING

The cash register provides an electronic journal (EJ) function. This function is intended to record the journal data in a memory instead of journal paper, and print the data as an EJ report. The register records the journal data in REG, PGM, , X1/Z1 and X2/Z2 modes. By default, a maximum of 9000 lines are stored in the memory. For details of EJ programming, please refer to "Other programming (Job code 68)" on page 64 and "EJ memory type" on page 67.

■ Printing journal data on the way of a transaction

You can print journal data of a current transaction recorded in EJ memory by pressing the  key during the transaction.

Note This function is valid when the printing style is programmed to receipt, and the receipt ON/OFF function is set to OFF. For changing the setting, refer to "Additional Information for BASIC SALES ENTRY".

• Sample print

* EJ *	EJ report title
22/05/2007 123456#000400	
13:02 01 DAVID	
DEPT. 07 *10.00	
DEPT. 08 *25.00	
* EJ END *	EJ report end title

■ Reading and resetting the electronic journal data (Issuing EJ report)

You can read the journal data stored in the EJ memory in the journal format by executing the following procedure in the X1/Z1 or OP X/Z mode.

To read all of the data:

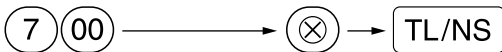

To reset all of the data:



To read the last 10 records:

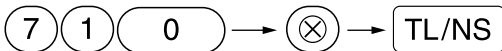

Note

- To stop reading or resetting the data, turn the mode switch to "MGR" position. The data will not be erased when resetting.
- On the EJ memory, a maximum of 9000 (or 8000, depending on programming) lines of data can be stored. When executing all data reading, all of the data stored in the EJ memory will be printed. Refer to "EJ memory type" for the programming.
- When printing is performed continuously, the printing may be intermitted several seconds. After the intermission, the printing will be restarted.

• Sample EJ report

```

*OPX*
* EJ *
22/05/2007 123456#000429
10:12 01 DAVID
***RA *2.50
22/05/2007 123456#000430
10:12 01 DAVID
*OPX*
* EJ *
22/05/2007 123456#000431
10:13 01 DAVID
NO SALE
22/05/2007 123456#000432

ITEMS TO
CASH *12.50
22/05/2007 123456#000435
10:14 01 DAVID
DEPT. 03 *31.50
PLU. 0002 *6.00
ITEMS 20
CASH *37.50
22/05/2007 123456#000436
10:14 01 DAVID
***RA *12.50
22/05/2007 123456#000437
10:14 01 DAVID
DEPT. 02 *6.10
PLU. 0001 *3.50
ITEMS 20
***TOTAL *9.60
CASH *10.00
CHANGE *0.40
22/05/2007 123456#000438
10:15 01 DAVID
PLU. 0005 *3.00
ITEMS 10
CASH *3.00
* EJ END *
    
```

OVERRIDE ENTRIES

Programmed limit for functions (such as for maximum amounts) can be overridden by making an entry in the MGR mode.

Procedure

1. Turn the mode switch to the MGR position.
2. Make an override entry.

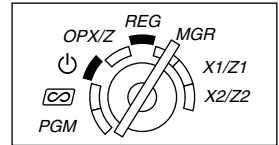

Example

In this example, the register has been programmed not to allow discounts entries over 1.00.

Key operation example

REG mode 1500 ¹⁹
 entries 250 ...Error

Turn the mode switch
to the MGR position.

250

Return the mode switch
to the REG position.

Print

```
DEPT. 03      *15.00
(-)           -2.50

ITEMS        1Q
CASH *12.50
```

CORRECTION AFTER FINALIZING A TRANSACTION (Void mode)

When you need to void incorrect entries that clerks cannot correct (incorrect entries found after finalizing a transaction or cannot be corrected by direct or indirect void), follow this procedure:

1. Turn the mode switch to the position using the manager key (MA), to enter into the void mode.
2. Repeat the entries that are recorded on an incorrect receipt. (All data on the incorrect receipt is removed from register memory; the voided amounts are added to the void mode transaction totalizer.)

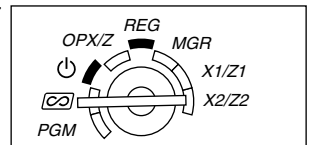

Incorrect receipt

```
DEPT. 04      *10.00
DEPT. 03      *1.50

ITEMS        2Q
CASH *11.50
```



Cancellation receipt

```
*⊙ MODE *
DEPT. 04      *10.00
DEPT. 03      *1.50

ITEMS        2Q
CASH *11.50
```

EURO MIGRATION FUNCTION

Note • EURO programming described in this section are for users in the countries which will join to the members of the European Currency Union, not for the users in the countries already have joined the Union.

Your register can be modified to correspond with each period set for the introduction of EURO, and in your register each currency is treated as shown on the table below depending on which period you are in. Basically your register can be automatically modified to correspond to the introduction of EURO by executing automatic EURO modification operation shown below in the X2/Z2 mode. However, there are several options you must set depending on your needs. So, please carefully conduct necessary settings.

How currencies are treated in your register

	Period 1	Period 2	Period 3
	After the introduction of EURO, and before EURO banknotes and coins begin to circulate	After EURO banknotes and coins begin to circulate, and before national currency is withdrawn from circulation. (Co-existence of EURO and national currency)	After the national currency is withdrawn from circulation
Currency	EURO	Exchange key (Preset rate entry)	Domestic currency
	National currency	Domestic currency	Exchange key (Preset rate entry)
	Foreign currency	Exchange key (Manual rate entry)	Exchange key (Manual rate entry)

Automatic EURO modification operation

Make sure the mode switch is in the X2/Z2 mode first, then perform the following procedure. Please note that you can perform each operation only once with the substitution of "A=1", "A=2" and "A=3". For example if you performed the operation with the substitution of "A=2" first, you cannot perform the operation with the substitution of "A=1".

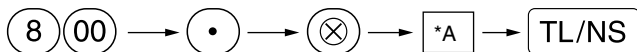

*A=1: Applicable for period 1

*A=2: Applicable for period 2

*A=3: Applicable for period 3

The details of the register system modification are as shown below:

Items	A=1 (EURO status 1)	A=2 (EURO status 2)	A=3 (EURO status 3)
General Z1 report	Issue	Issue	Issue
General Z2 report	Issue	Issue	Issue
GT memories (GT1, GT2, GT3 and Training GT)	-	Clear	Clear*1
Conversion of preset prices of Dept./PLU	-	Yes	Yes*1
Conversion of entry digit/amount limit	-	Yes	Yes*1
Exchange amount printing for total and change	Yes	Yes	No
Exchange calculation method	Division	Multiplication	Multiplication
Domestic currency symbol	-	[EURO]	[EURO]
Domestic currency decimal point position	-	2	2
Exchange currency symbol	[EURO]	Previous domestic currency symbol	-*2
Exchange currency decimal point position	2	Previous domestic currency decimal point position	-
Rounding system (Denmark/Sweden/Normal)	-	Normal	Normal*1
Rounding up/down of the unit digits of amount	-	No	No*1
Lowest digit entering limitation of item	-	Arbitrary	Arbitrary*1
Lowest digit entering limitation of payment	-	Arbitrary	Arbitrary*1
Memory of difference due to rounding	-	No	No*1
Rounding of exchange currency	Round off (4 down/5 up)	Round off	Round off

- The item marked with “-” remains the same as the previous data.
- *1: When you perform from EURO status 2, previous data remains unchanged.
- *2: When you perform from EURO status 1 or 2, “space” is set.

IMPORTANT

- Conversion of the preset unit prices of departments and PLUs
Note that the conversion rate of the preset rate of the **[EX]** key is applied for the conversion, and the method is set to “division”. When the conversion is performed, the message “PRICE CONVERTED” will be printed on the #800 report.
- After the execution of the procedure with “A=1”, treat EURO as foreign currency using the exchange key **[EX]** with the preset rate entry. Set the EURO conversion rate as the currency exchange rate for the exchange key.
- After the execution of the procedure with “A=2”, treat EURO as domestic currency, and national currency as foreign currency using the exchange key **[EX]** with the preset rate entry. Set the EURO conversion rate as the currency exchange rate for the exchange key.
- As for the percent rate for **[%1]**, **[%2]** and **[⊖]**, the automatic conversion is not made. So, when your domestic currency becomes EURO, you must change these settings so that they are base on EURO currency.

Note

You can manually make these settings. For programming details, please refer to “EURO Programming” section.

Checking the current EURO status

You can check the EURO status currently set on the cash register. Set the manager key (MA) to the X2/Z2 position, and perform the following sequence. The current EURO status will be printed on the receipt/journal.

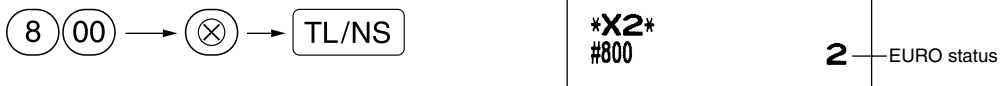

Optional Programming for the Introduction of EURO

Some programming relating with the function of exchange key (EX) cannot be changed automatically with the execution of modification operation described in the previous section. After the execution on each period, conduct the following programming depending on your needs.

Programming for Exchange Key (EX)

Currency exchange rate

For period 1 and period 2, set the EURO conversion rate.
For programming details, refer to “Programming for EX” on page 51.

Exchange rate entry selection

When you treat EURO currency in the exchange key, you must apply preset rate entry. So, make enable for preset rate entry for period 1 and period 2. For programming details, refer to “Programming for EX” on page 51.

Cheque/credit operation

For period 1 and period 2, enable cheque/credit operation when tendering in foreign currency so that you can treat cheque and credit for EURO currency and national currency. For programming details, refer to “EURO system settings” on page 69.

Setting the date and time when the automatic modification operation for EURO should be executed

Selection of compulsory/non-compulsory of execution of the automatic modification operation for EURO

You can program the scheduled date and time to execute the automatic EURO modification operation .
From ten days before the preset date, the remaining days are printed at the bottom of the daily full resetting (Z1) report as follows.

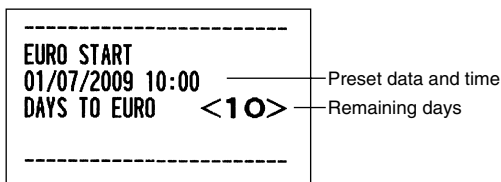

When the above-mentioned preset date and time has come, and also when you start an entry in the REG/MGR mode, the error message “EURO CHANGE” is displayed. You cannot make any operation in the REG/MGR mode until you execute the automatic modification operation for EURO (job #800) in the X2/Z2 mode.
You can program so that you can make entries in the REG/MGR mode even when the error message is displayed.

Date and time setting will be reset after the execution of the automatic modification operation and you can program again the date and time for the next automatic modification operation.

OPERATOR MAINTENANCE

1 In Case of Power Failure

When power is lost, the machine retains its memory contents and all information on sales entries.

- When power failure is encountered in register idle state or during an entry, the machine returns to normal operation after power recovery.
- When power failure is encountered during a printing cycle, the register prints "===== " and then carries out the correct printing procedure after power recovery. (See the sample print.)

C#16	CLERK 16
C#17	CLERK 17
=====	
C#17	CLERK 17
C#18	CLERK 18

2 In Case of Printer Error

If the printer runs out of paper, the printer will stall, and "PAPER EMPTY" will appear on the display. Key entries will not be accepted. Refer to section 5 in this chapter, install a new roll, then press the (CL) key. The printer will print the power failure symbol and resume printing.

If the print roller arm comes up, the printer stalls, "HEAD UP" will appear on the display. Key entries will not be accepted. Push down the arm until it is securely locked, then press the (CL) key. The printer will print the power failure symbol and resume printing.

3 Cautions in Handling the Printer and Recording Paper

■ Cautions in handling the printer

- Avoid dusty and humid environments, direct sunlight and iron powder. (A permanent magnet and electromagnet are used in this machine.)
- Never pull the paper when the print roller arm is locked. First lift up the arm, and then remove the paper.
- Never touch the surface of the print head and print roller.

■ Cautions in handling the recording paper (thermal paper)

- Use only the paper specified by SHARP.
- Do not unpack the thermal paper until you are ready to use it.
- Avoid heat. The paper will color at around 70°C.
- Avoid dusty and humid storage places. Avoid direct sunlight.
- The printed text on the paper can discolor under conditions of high humidity and temperature, exposure to the direct sunlight, contact with glue, thinner or a freshly copied blueprint, and heat caused by friction from scratching or other such means.
- Be very careful when handling the thermal paper. If you want to keep a permanent record, copy the printed text with a photocopier.

4 Replacing the Batteries

This cash register displays a low battery warning message “LOW BATTERY” when the batteries are low, and displays a no battery warning message “NO BATTERY” when batteries are extremely low or batteries are not installed.

When the low battery message is displayed, replace the batteries with new ones as soon as possible. The existing batteries will be dead in about two days.

When the no battery message is displayed, replace the batteries immediately. Otherwise, if the AC power cord is disconnected or a power failure occurs, all the programmed settings will be reset to the default settings and any data stored in memory will be cleared.

While the no battery message is being displayed, do not turn the mode switch to any positions. Follow the battery replacement procedure below without changing the mode switch position. Otherwise, if the mode switch passes or is set to the , all the programmed settings will be reset to the default settings and any data stored in memory will be cleared.

Note Be sure to observe precautions shown on page 1 when handling batteries.

To replace the batteries:

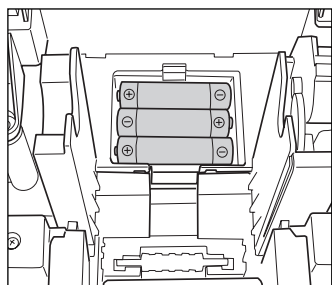

1. Make sure that the cash register is plugged in.
2. Remove the printer cover.
3. Open the battery compartment cover next to the paper roll cradle and remove the old batteries.
4. Install three new alkaline batteries LR6 (“AA” size) in the battery compartment. Be sure the positive and negative poles of each battery are facing in the proper direction. When they are installed correctly, the “LOW BATTERY” or “NO BATTERY” will disappear.
5. Close the battery compartment cover.
6. Replace the printer cover.

5 Replacing the Paper Roll

Be sure to use paper rolls specified by SHARP.

The use of any other paper rolls other than those specified could cause paper jamming, resulting in register malfunction.

Paper specification

Paper width: 57.5 ± 0.5 mm

Max. outside diameter: 80 mm

Quality: Thermal paper

- Be sure to set the paper roll prior to using your machine, otherwise it may cause a malfunction.

Install the paper roll in the printer. Be careful to set the roll correctly.

(How to set the paper roll)

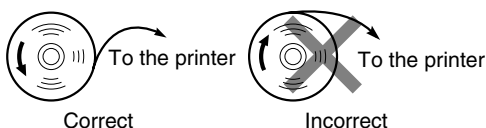

■ Removing the paper roll

When a red dye appears on the paper roll, it is time to replace it. Replace the paper roll with a new one. If you plan on not using the register for an extended period of time, remove the paper roll, and store it in an appropriate place.

Caution: The paper cutter is mounted on the printer cover. Be careful not to cut yourself.

When not using the take-up spool (using as receipt paper):

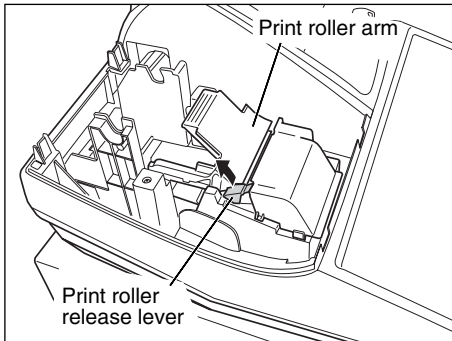

1. Remove the printer cover.
2. Lift up the print roller release lever to unlock and open the print roller arm.
3. Remove the paper roll from the paper roll cradle.

Note Do not pull the paper through the printer.

When using the take-up spool (using as journal paper):

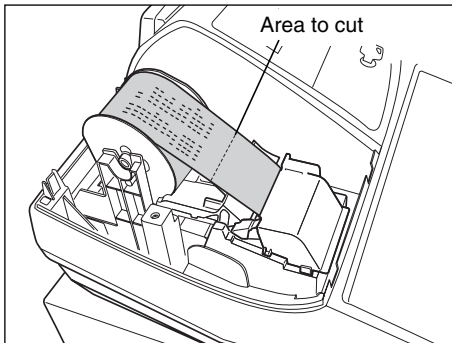

1. Turn the mode switch to a position other than “⏻” with the power cord connected.
2. Remove the printer cover.
3. Press the  key to advance the journal paper until its printed part is out of the way.
4. Cut the paper and remove the take-up spool.
5. Lift up the print roller release lever to unlock and open the print roller arm.
6. Remove the paper roll from the paper roll cradle.

Note Do not pull the paper through the printer.

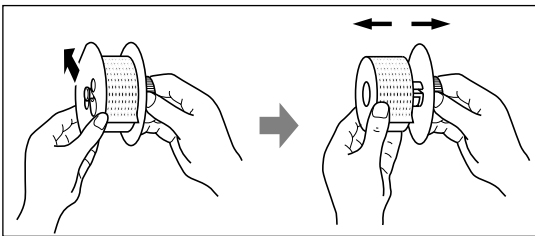

7. Remove the outer side of the take-up spool as shown on the left.
8. Remove the printed journal roll from the take-up spool.

■ Installing the paper roll

Caution: The paper cutter is mounted on the printer cover. **Be careful not to cut yourself.**

Installing the receipt paper roll:

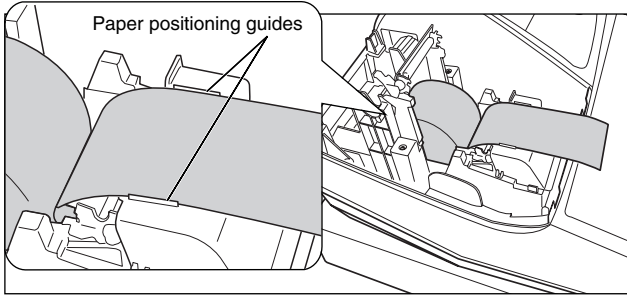

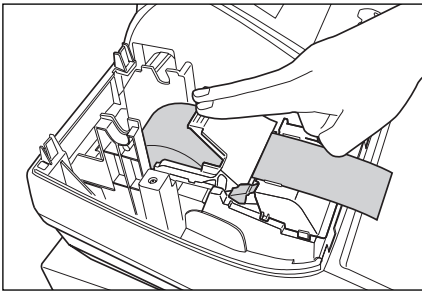

1. Turn the mode switch to a position other than “⏻” with the power cord connected.
2. Remove the printer cover.
3. Lift up the print roller release lever to unlock and open the print roller arm.
4. Set the paper correctly in the paper roll cradle.
5. Feed the end of the paper along with the paper positioning guides.

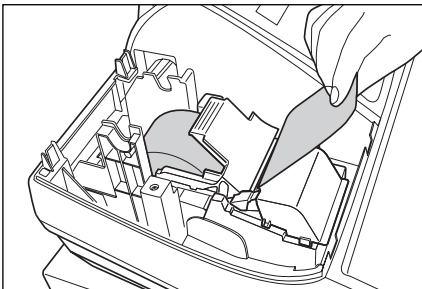

6. While holding down the paper, slowly close the print roller arm, and push down the arm until you hear a click locking the arm. Make sure securely you push down the center of the wing part of the arm as per the diagram. The paper will be fed automatically.

Note *If the print roller arm is not securely locked, printing is not done right. If this problem occurs, open the arm, and close the arm as instructed above.*



7. Cut off the excess paper using the edge of the inner cover, and replace the printer cover. Press the  key to make sure the paper end comes out of the printer cover and clean paper appears.

Note *If the paper end does not come out, open the printer cover, and pass the paper end between the paper cutter and the paper guide of the printer cover, and replace the cover.*

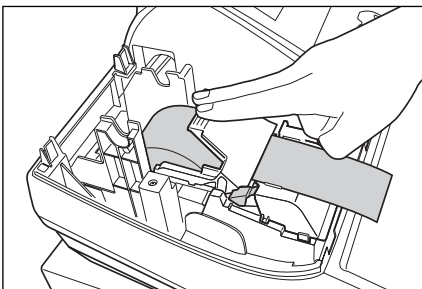

Installing the journal paper roll:

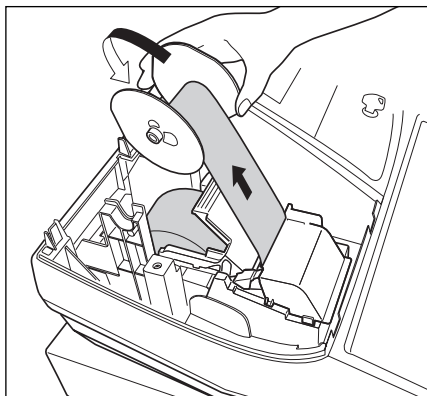

1. Turn the mode switch to a position other than “⏻” with the power cord connected.
2. Remove the printer cover.
3. Lift up the print roller release lever to unlock and open the print roller arm.
4. Set the paper correctly in the paper roll cradle.
5. Feed the end of the paper along with the paper positioning guides.
6. While holding down the paper, slowly close the print roller arm, and push down the arm until you hear a click locking the arm. Make sure securely you push down the center of the wing part of the arm as per the diagram. The paper will be fed automatically.

Note *If the print roller arm is not securely locked, printing is not done right. If this problem occurs, open the arm, and close the arm as instructed above.*



7. Insert the end of the paper into the slit in the spool. (Press the  key to feed more paper if required.)
8. Wind the paper two or three turns around the spool shaft.
9. Set the spool on the bearing, and press the  key to take up excess slack in the paper.
10. Replace the printer cover.

Note

You can wind the roll paper in OP X/Z, X1/Z1, and X2/Z2 modes even if you programmed so that the printer is used for issuance of receipts. This may be convenient to wind reports. In this case, set the roll paper to the take-up spool.

6 Removing a Paper Jam

Caution: The paper cutter is mounted on the printer cover. Be careful not to cut yourself. Never touch the print head immediately after printing, as the head may still be hot.

1. Remove the printer cover.
2. Lift up the print roller release lever to unlock and open the print roller arm.
3. Remove the paper jam. Check for and remove any shreds of paper that may remain in the printer.
4. Reset the paper roll correctly by following the steps in "Installing the paper roll".

7 Cleaning the Printer (Print Head / Sensor / Roller)

When the printed text is getting dark or faint, paper dust may be stuck to the print head, sensor and/or roller. Clean them as follows:

Caution:

- Never touch the print head with a tool or anything hard as it may damage the head.
- The paper cutter is mounted on the printer cover. Be careful not to cut yourself.

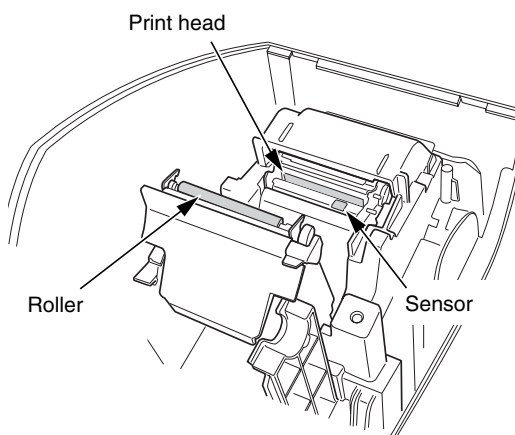

1. Turn the mode switch to the "⏻" position.
2. Remove the printer cover.
3. Lift up the print roller release lever to unlock and open the print roller arm.
4. Remove the paper roll referring to the "Removing the paper roll" section.
5. Clean the print head with a cotton swab or soft rag moistened with ethyl alcohol or isopropyl alcohol. Clean the roller and the sensor in the same manner.
6. Reset the paper roll correctly by following the steps in "Installing the paper roll".

8 Removing the Till and the Drawer

The till in the register is detachable. After closing your business for the day, remove the till from the drawer and keep the drawer open. The 8-denomination coin case is also detachable from the till. To detach the drawer, pull it forward fully with the till removed, and remove it by lifting it up.

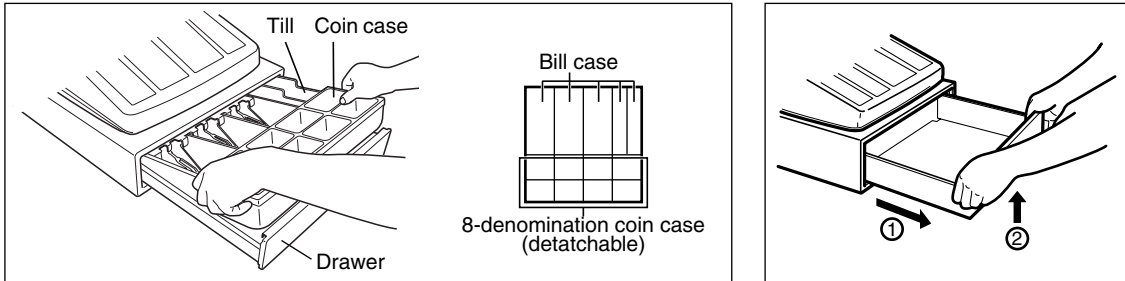

9 Opening the Drawer by Hand

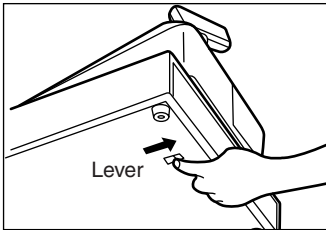

The drawer automatically opens. However, when a power failure occurs or the machine becomes out of order, slide the lever located on the bottom of the machine in the direction of the arrow. (See the diagram at the left.) The drawer will not open if it is locked with the key.



10 Before Calling for Service

The malfunctions shown in the left-hand column below, labelled "Fault," do not necessarily indicate functional faults of the machine. It is therefore advisable to refer to "Checking" shown in the right-hand column before calling for service.

Fault	Checking
(1) The display shows symbols that do not make sense.	<ul style="list-style-type: none"> Has the machine been initialized properly as shown in "PREPARING THE CASH REGISTER" on page 8? (Note that initialization clears all the data and programmed settings stored in memory.)
(2) The display won't illuminate even when the mode switch is turned to any other position than "☺".	<ul style="list-style-type: none"> Is power supplied to the electrical outlet? Is the power cord plug out or loosely connected to the AC outlet?
(3) The display is illuminated, but the whole machine refuses registrations.	<ul style="list-style-type: none"> Is a clerk code assigned to the register? Is the mode switch set properly at the "REG" position?
(4) No receipt is issued.	<ul style="list-style-type: none"> Is the paper roll properly installed? Is there a paper jam? Is the receipt function in the "OFF" status? Is the print roller arm securely locked?
(5) No journal paper is taken up.	<ul style="list-style-type: none"> Is the take-up spool installed on the bearing properly? Is there a paper jam?
(6) Printing is unusual.	<ul style="list-style-type: none"> Is the print roller arm securely locked? Open the print roller arm, and lock the arm by following the instruction of installation. Is the paper roll properly installed? Are the print head/sensor/roller clean?
(7) Continuous printing stops.	<ul style="list-style-type: none"> Display shows "→ → → → →". Printing will automatically restart after several seconds.

■ Error message table

When the following error messages are displayed, press the  key and take a proper action according to the table below.

Error message	Error status	Action
ENTRY ERROR	Registration error	Make a correct key entry.
MISOPERATION	Misoperation error	Make a correct key entry.
NO RECORD	Undefined code is entered.	Enter a correct code.
MEMORY FULL	Memory is full (in the AUTO key programming).	Program the AUTO key within 25 steps.
SBTL COMPUL.	Compulsory depression of the  key for direct finalization	Press the  key and continue the operation.
TEND COMPUL.	Compulsory tendering	Make a tendering operation.
NOT ASSIGNED	No entry of a clerk code	Make a clerk code entry.
OVER LIMIT.	Overflow limitation error	Make a registration within a limit of entry.
INH. OPEN PR	The open price entry is inhibited.	Make a preset price entry.
INH. UNIT PR	The preset price entry is inhibited.	Make an open price entry.
NOT NON-TEND	The direct finalization is inhibited.	Make a tendering operation.
BUFFER FULL	Subtotal void is not allowed.	Finalize the transaction, and correct the wrong entries in the  mode.
HEAD UP	Print roller arm is lifted up.	Make sure the print roller arm is surely rocked.
PAPER EMPTY	Receipt or journal paper roll is not installed or empty.	Install a receipt or journal paper.
EURO CHANGE	EURO modification operation must be executed	Execute EURO modification operation (Job code 800).

SPECIFICATIONS

Model:	XE-A203		
Dimensions:	355 (W) x 430 (D) x 312 (H) mm		
Weight:	11 kg		
Power source:	Official (nominal) voltage and frequency		
Power consumption:	Stand-by: 11.5W (When the official voltage is 220 to 230 V) Stand-by: 11.4W (When the official voltage is 230 to 240 V) Operating: 41.4W (When the official voltage is 220 to 230 V) Operating: 41.8W (When the official voltage is 230 to 240 V)		
Working temperature:	0 °C to 40 °C		
Electronics:	LSI (CPU) etc.		
Display:			
Operator display:	Dot matrix display (16 positions and 1 line)		
Customer display:	7-segment display (7 positions)		
Printer:			
Type:	One-station thermal printer		
Printing speed:	Approx. 12 lines/second		
Printing capacity:	24 digits each for receipt/journal paper		
Other functions:	<ul style="list-style-type: none"> • Graphic logo printing function • Logo message function • Receipt (ON-OFF) function • Compression print for journal 		
Paper roll:	Width: 57.5 ± 0.5 mm Max. diam.: 80 mm Quality: High quality (0.06 to 0.08 mm thickness)		
Cash drawer:	5 slots for bill and 8 for coin denominations		
Accessories:			
	Manager key		2
	Operator key		2
	Drawer lock key		2
	Paper roll		1
	Take-up spool		1
	Instruction manual		1 copy
	Reset caution sheet		1 copy
	Battery caution sheet		1 copy
	"Where to Find" sheet		1 copy

* Specifications and appearance subject to change without notice for improvement.

Use these labels with the department keys. Write department names on the labels and attach them to the department keys by first removing the transparent key covers. (Please make a copy of this page.)

Example:

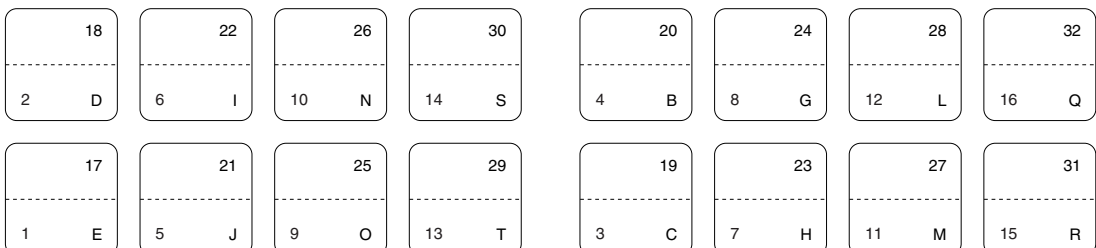



Attention: Your product is marked with this symbol. It means that used electrical and electronic products should not be mixed with general household waste. There is a separate collection system for these products.

A. Information on Disposal for Users (private households)

1. In the European Union

Attention: If you want to dispose of this equipment, please do not use the ordinary dust bin!

Used electrical and electronic equipment must be treated separately and in accordance with legislation that requires proper treatment, recovery and recycling of used electrical and electronic equipment.

Following the implementation by member states, private households within the EU states may return their used electrical and electronic equipment to designated collection facilities free of charge*. In some countries* your local retailer may also take back your old product free of charge if you purchase a similar new one.

*) Please contact your local authority for further details.

If your used electrical or electronic equipment has batteries or accumulators, please dispose of these separately beforehand according to local requirements.

By disposing of this product correctly you will help ensure that the waste undergoes the necessary treatment, recovery and recycling and thus prevent potential negative effects on the environment and human health which could otherwise arise due to inappropriate waste handling.

2. In other Countries outside the EU

If you wish to discard this product, please contact your local authorities and ask for the correct method of disposal.

For Switzerland: Used electrical or electronic equipment can be returned free of charge to the dealer, even if you don't purchase a new product. Further collection facilities are listed on the homepage of www.swico.ch or www.sens.ch.

B. Information on Disposal for Business Users.

1. In the European Union

If the product is used for business purposes and you want to discard it:

Please contact your SHARP dealer who will inform you about the take-back of the product. You might be charged for the costs arising from take-back and recycling. Small products (and small amounts) might be taken back by your local collection facilities.

For Spain: Please contact the established collection system or your local authority for take-back of your used products.

2. In other Countries outside the EU

If you wish to discard of this product, please contact your local authorities and ask for the correct method of disposal.

FOR CUSTOMERS IN U.K.

IMPORTANT

The wires in this mains lead are coloured in accordance with the following code:

BLUE:	Neutral
BROWN:	Live

As the colours of the wires in the mains lead of this apparatus may not correspond with the coloured markings identifying the terminals in your plug proceed as follows.

The wire which is coloured **BLUE** must be connected to the terminal which is marked with the letter **N** or coloured black.

The wire which is coloured **BROWN** must be connected to the terminal which is marked with the letter **L** or coloured red.

The apparatus must be protected by a 3A fuse in the mains plug or distribution board.

CAUTION: DO NOT CONNECT THE LIVE (BROWN) WIRE OR THE NEUTRAL (BLUE) WIRE TO THE EARTH TERMINAL OF YOUR 3-PIN MAINS PLUG.

Environment Protection

The device is supported by a battery. To dispose the battery safely to protect the environment, please note the following points:

- Take the used battery to your local waste depot, dealer or customer service centre for recycling.
- Do not throw the used battery into fire, into water or into the household waste!

Umweltschutz

Das Gerät wird durch eine Batterie gestützt. Um die Batterie sicher und umweltschonend zu entsorgen, beachten Sie bitte folgende Punkte:

- Bringen Sie die leere Batterie zu Ihrer örtlichen Mülldeponie, zum Händler oder zum Kundenservice-Zentrum zur Entsorgung.
- Werfen Sie die leere Batterie niemals ins Feuer, ins Wasser oder in den Hausmüll.

Protection de l'environnement

L'appareil est supporté sur pile. Afin de protéger l'environnement, nous vous recommandons de traiter la pile usagée la façon suivante:

- Apporter la pile usagée à votre centre de traitement des ordures ménagères le plus proche ou, à votre revendeur ou, au service après-vente, pour recyclément.
- Ne jamais jeter la pile usagée dans une source de chaleur, dans l'eau ou dans les vide-ordures.

Miljöskydd

Denna produkt nöddrivs av batteri.

Vid batteribyte skall följande iakttagas:

- Det förbrukade batteriet skall inlämnas till er lokala handlare eller till kommunal miljöstation för återinsamling.
- Kasta ej batteriet i vattnet eller i hushållssoporna. Batteriet får ej heller utsättas för öppen eld.

Bescherming van het milieu

Deze kassa gebruikt een batterij. Bescherm het milieu en gooi een gebruikte batterij op de juiste manier weg. Let op de volgende punten:

- Breng een lege batterij naar de lokale verzamelplaats voor klein chemisch afval, terug naar de winkel of gooi in een batterijbak.
- Gooi een gebruikte batterij niet in een vuur of water en gooi niet met het gewone huisafval weg.

Geräuschpegel L_{pA}: 64,7 dB
Gemessen nach EN ISO 7779:2001

SHARP

SHARP ELECTRONICS (Europe) GmbH

Sonninstraße 3, D-20097 Hamburg

SHARP CORPORATION